

OHARRAK :
NOTAS :

Leyenda de cerraduras:

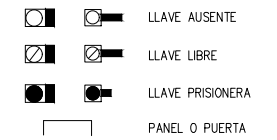

Notas:

- La posición de las llaves corresponde a los interruptores y seccionadores, conectados y en posición de funcionamiento.
- Los enclavamientos de las demás celdas serán los mismos que los ya especificados.
- Los transformadores de intensidad para medida y protección se ajustarán a la potencia de los transformadores.

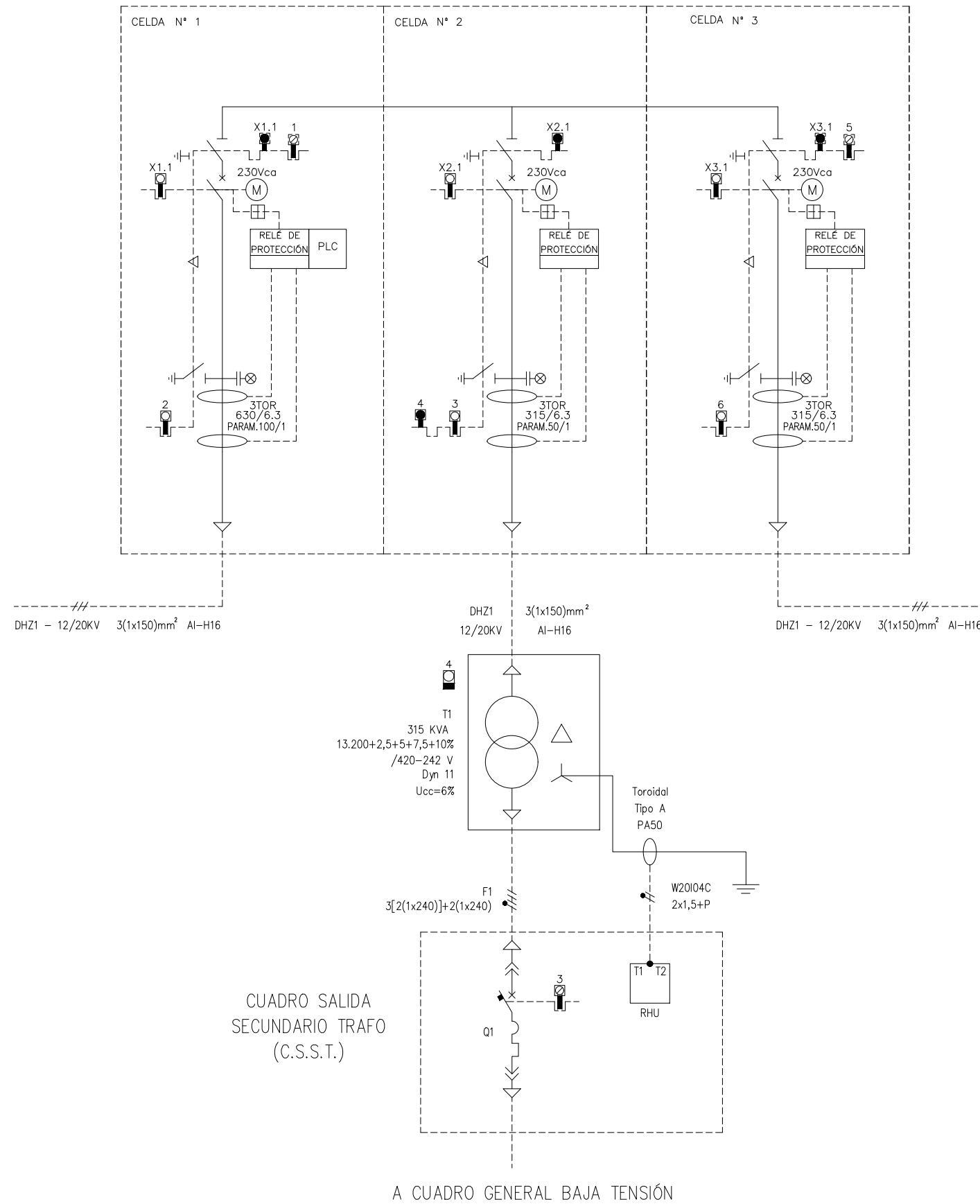

REV.	CLASE DE MODIFICACION	FECHA	NOMBRE	COMP.	OBRA
A	PRIMERA EMISION	MAR. 23	IAA	ETS	
BERRIKUSPENAK / REVISIONES					
AHOLKULARIA / CONSULTOR			INGENIARI EGILEA INGENIERO AUTOR		
CAF TURNKEY ENGINEERING			IKER AIZPURU ARAGON - Nº COL. 1999		
AHOLKULARIAREN ERREFERENTZIA REFERENCIA CONSULTOR			ERREFERENTZIA REFERENCIA		
TTE-IS-23001-DRW-0100			2RVA-IE-22-100-A		

OHARRAK :
NOTAS :
* PUENTEADO EN BORNERO

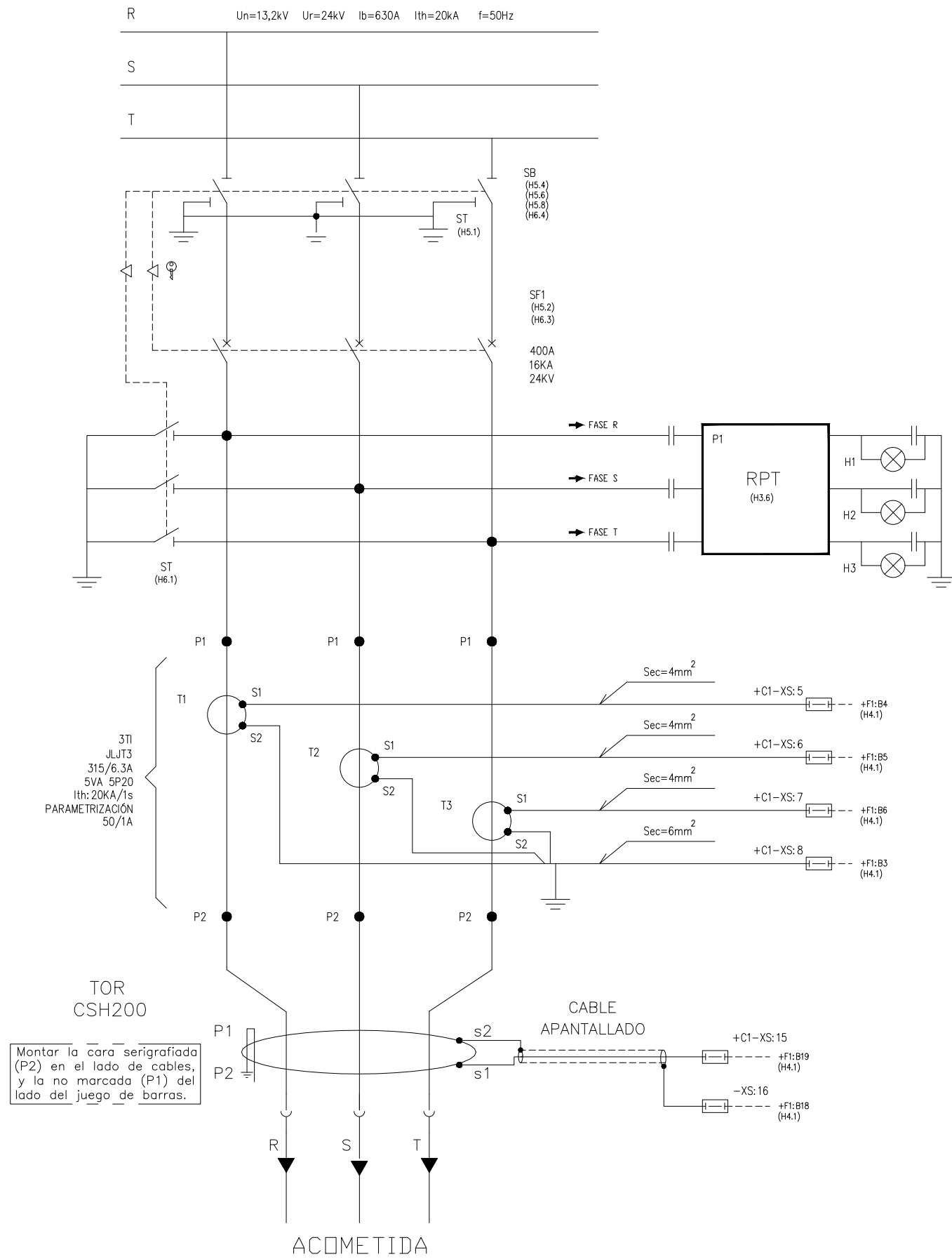

+A1.C1 CIRCUITO DE POTENCIA

REV.	CLASE DE MODIFICACION	FECHA	NOMBRE	COMP.	OBRA
A	PRIMERA EMISION	MAR. 23	IAA	ETS	

BERRIKUSPENAK / REVISIONES

AHOLKULARIA / CONSULTOR	INGENIARI EGILEA INGENIERO AUTOR
CAF TURNKEY ENGINEERING	
	IKER AIZPURU ARAGON - Nº COL. 1999

AHOLKULARIAREN ERREFERENTZIA REFERENCIA CONSULTOR	ERREFERENTZIA REFERENCIA
--	-----------------------------

TTE-IS-23001-DRW-0101	2RVA-IE-22-101-A
-----------------------	------------------

1 2 3 4 5 6 7 8 9 10

ACOMETIDA DESDE CUADRO GENERAL DE SAI

A CABINA SIGUIENTE

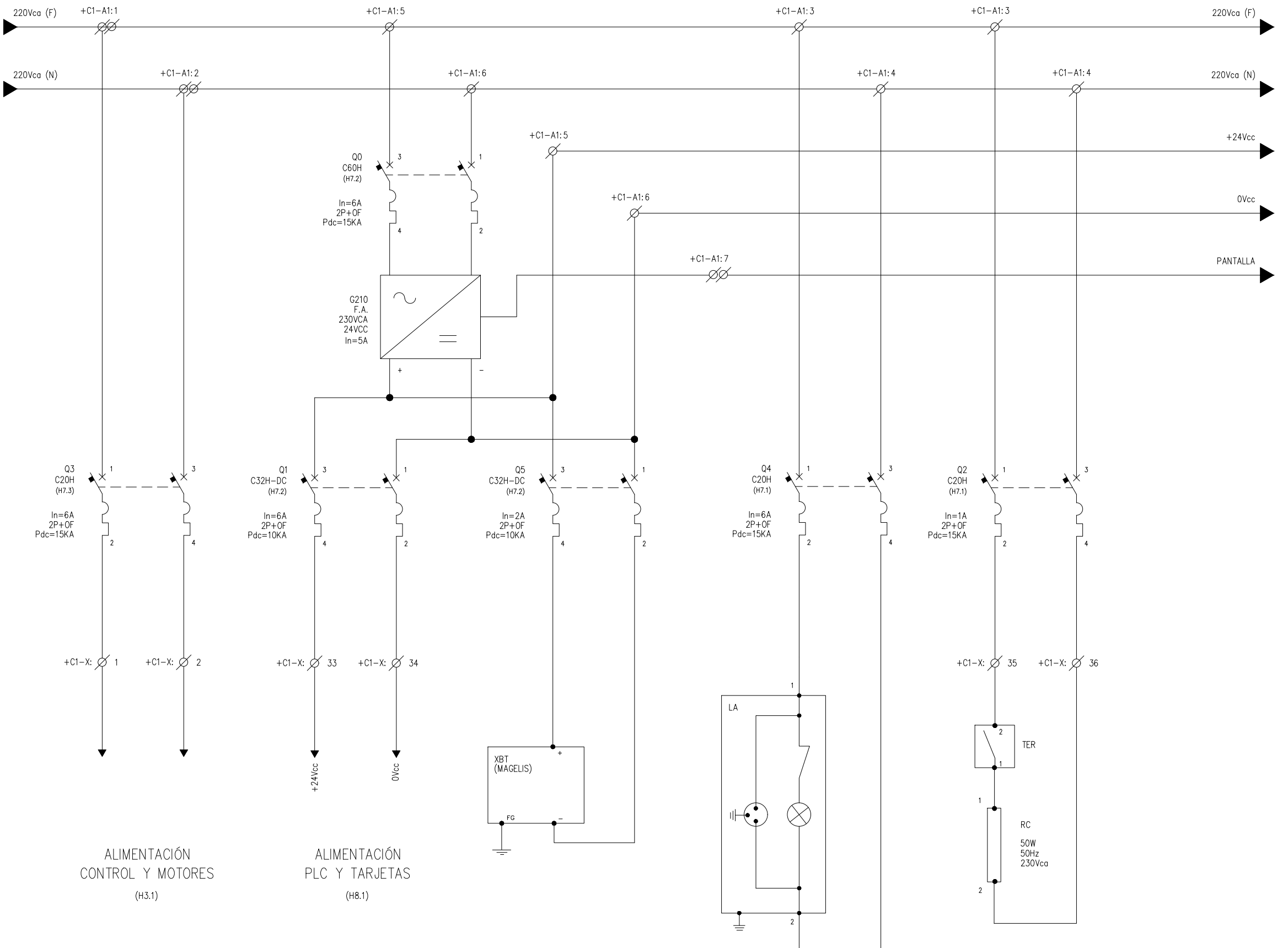

ALIMENTACIÓN CONTROL Y MOTORES (H3.1)

ALIMENTACIÓN PLC Y TARJETAS (H8.1)

+A1.C1 ACOMETIDAS TENSIONES AUXILIARES

OHARRAK :
NOTAS :

* PUENTEADO EN BORNERO

REV.	PRIMERA EMISIÓN	MAR. 23	IAA	ETS
REV.	CLASE DE MODIFICACION	FECHA	NOMBRE	COMP. OBRA

BERRIKUSPENAK / REVISIONES

AHOLKULARIA / CONSULTOR	INGENIARI EGILEA INGENIERO AUTOR
CAF TURNKEY ENGINEERING	<i>[Signature]</i>
IKER AIZPURU ARAGON - Nº COL. 1999	

AHOLKULARIAREN ERREFERENTZIA REFERENCIA CONSULTOR	ERREFERENTZIA REFERENCIA
TTE-IS-23001-DRW-0102	2RVA-IE-22-102-A

OHARRAK :
NOTAS :

* PUENTEADO EN BORNERO

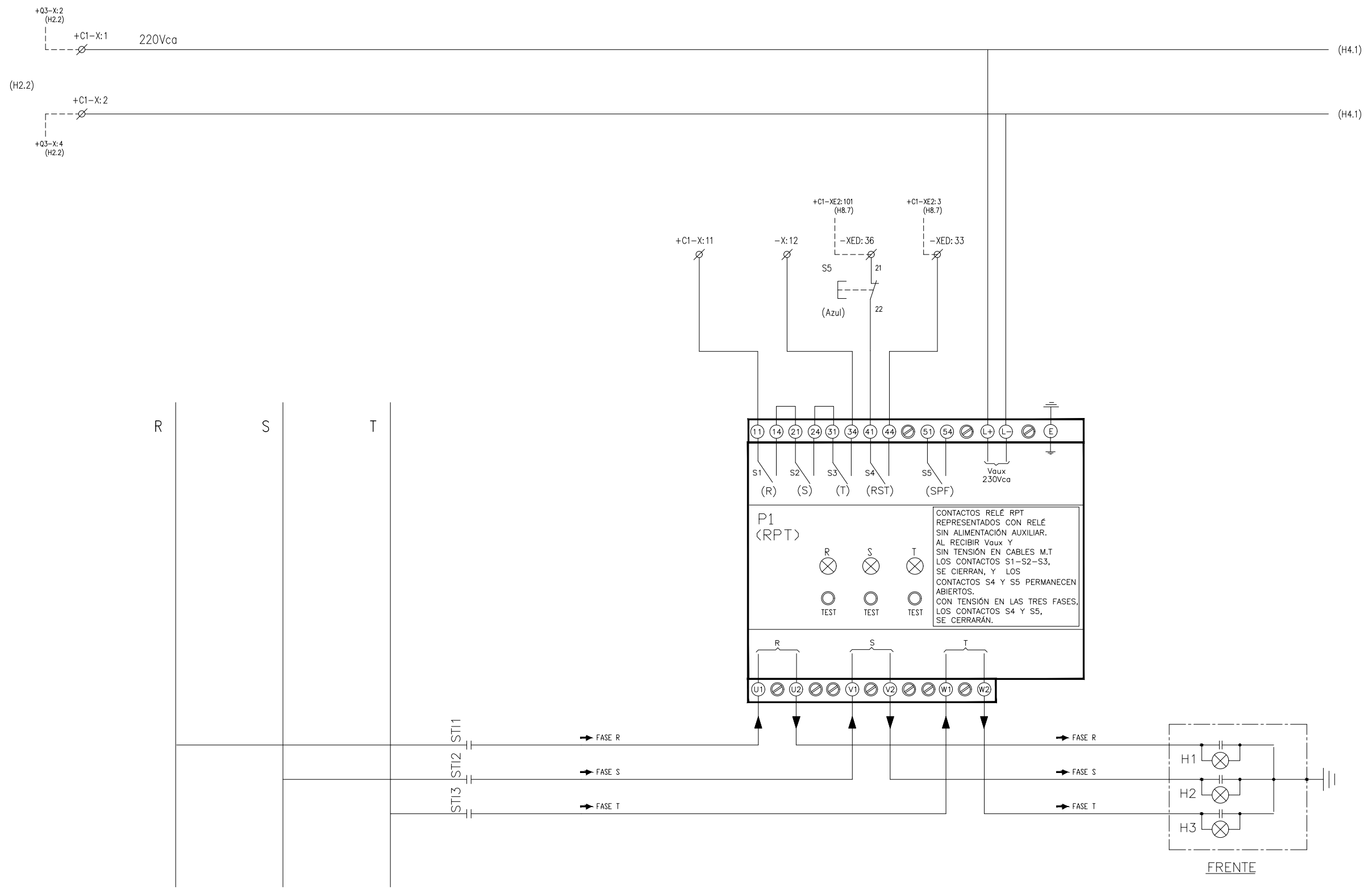

FALTA FASE	PRESENCIA TENSIÓN	PRESENCIA DE TENSIÓN
------------	-------------------	----------------------

+A1.C1 DETALLE RELÉ PRESENCIA DE TENSIÓN (RPT)

REV.	CLASE DE MODIFICACION	FECHA	NOMBRE	COMP.	OBRA
A	PRIMERA EMISION	MAR. 23	IAA	ETS	
BERRIKUSPENAK / REVISIONES					
AHOLKULARIA / CONSULTOR			INGENIARI EGILEA INGENIERO AUTOR		
CAF TURNKEY ENGINEERING					
AHOLKULARIAREN ERREFERENTZIA REFERENCIA CONSULTOR			ERREFERENTZIA REFERENCIA		
TTE-IS-23001-DRW-0103			2RVA-IE-22-103-A		

* PUENTEADO EN BORNERO

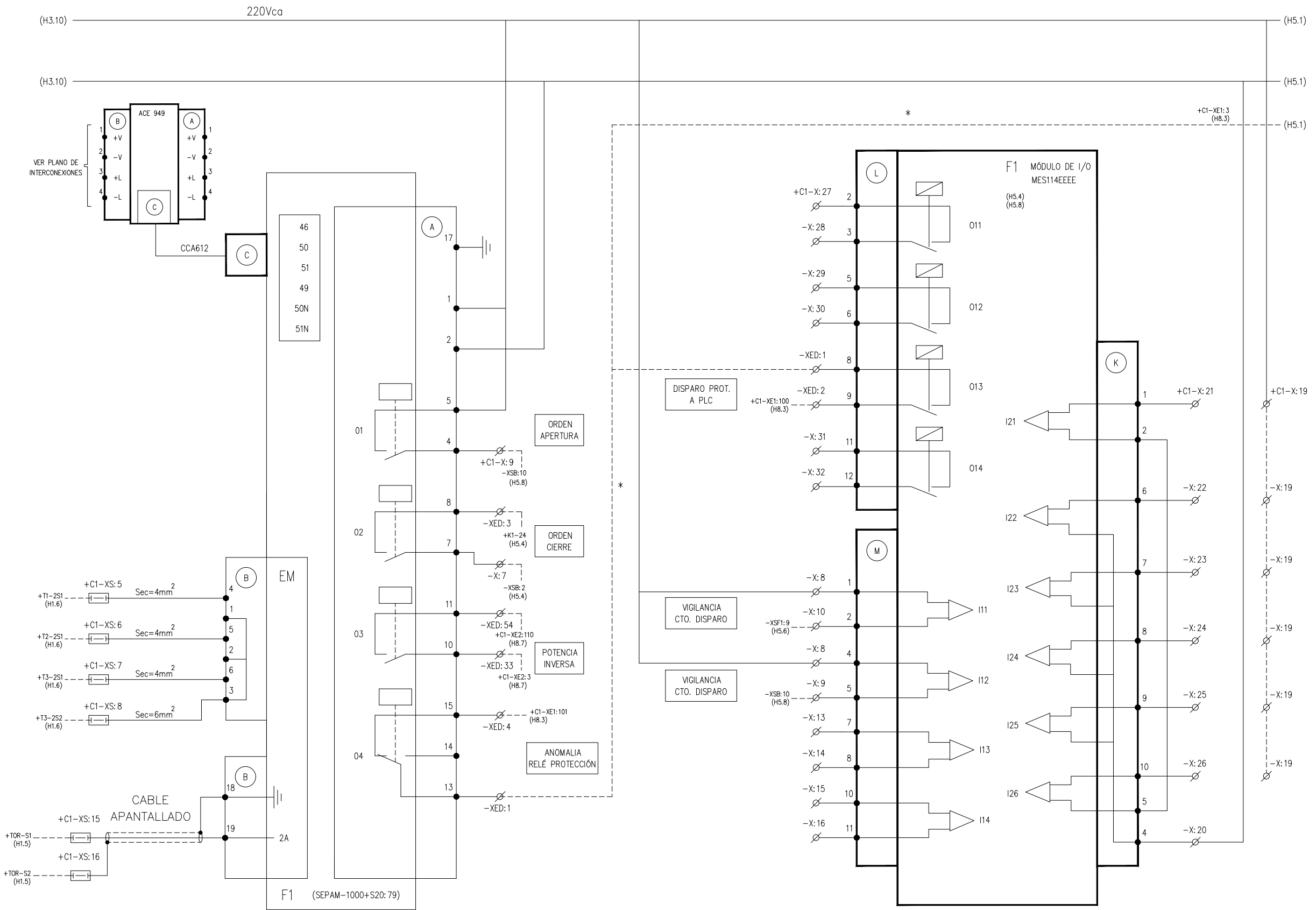

RELÉ PROTECCIÓN TIPO SEPAM-1000 E INTERFACE COMUNICACIÓN CON PLC ACE949 MÓDULO DE ENTRADAS / SALIDAS ADICIONALES PARA SEPAM 1000 EN Vcc

+A1.C1 DETALLE RELÉ DE PROTECCIÓN SEPAM-1000 SERIE 20

REV.	A	PRIMERA EMISIÓN	MAR. 23	IAA	ETS
REV.		CLASE DE MODIFICACION	FECHA	NOMBRE	COMP. OBRA
BERRIKUSPENAK / REVISIONES					
AHOLKULARIA / CONSULTOR			INGENIARI EGILEA INGENIERO AUTOR		
TTE-IS-23001-DRW-0104			2RVA-IE-22-104-A		

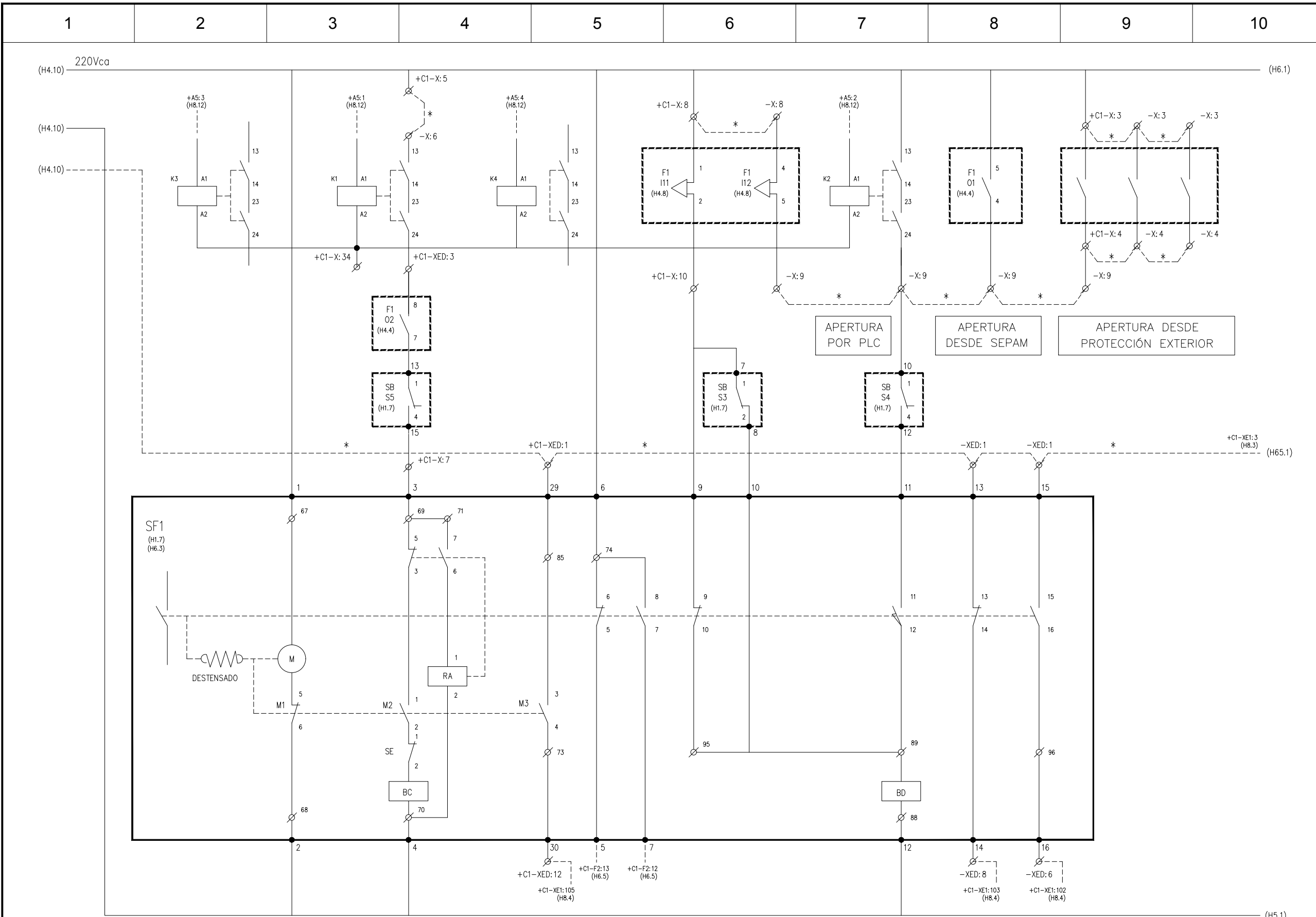

OHARRAK :
NOTAS :

* PUENTEADO EN BORNERO

MOTOR	CIERRE Y ENCLAVAMIENTO	MUELLES TENSADOS	ESTADO DISYUNTOR	VIGILANCIA CIRCUITO DISPARO	APERTURA	DISYUNTOR
						ABIERTO CERRADO

+A1.C1 DETALLE DISYUNTOR SF1

REV.	CLASE DE MODIFICACION	FECHA	NOMBRE	COMP.	OBRA
A	PRIMERA EMISION	MAR. 23	IAA	ETS	
BERRIKUSPENAK / REVISIONES					
AHOLKULARIA / CONSULTOR			INGENIARI EGILEA INGENIERO AUTOR		
CAF			TURNKEY ENGINEERING		
AHOLKULARIAREN ERREFERENTZIA REFERENCIA CONSULTOR			ERREFERENTZIA REFERENCIA		
TTE-IS-23001-DRW-0105			2RVA-IE-22-105-A		

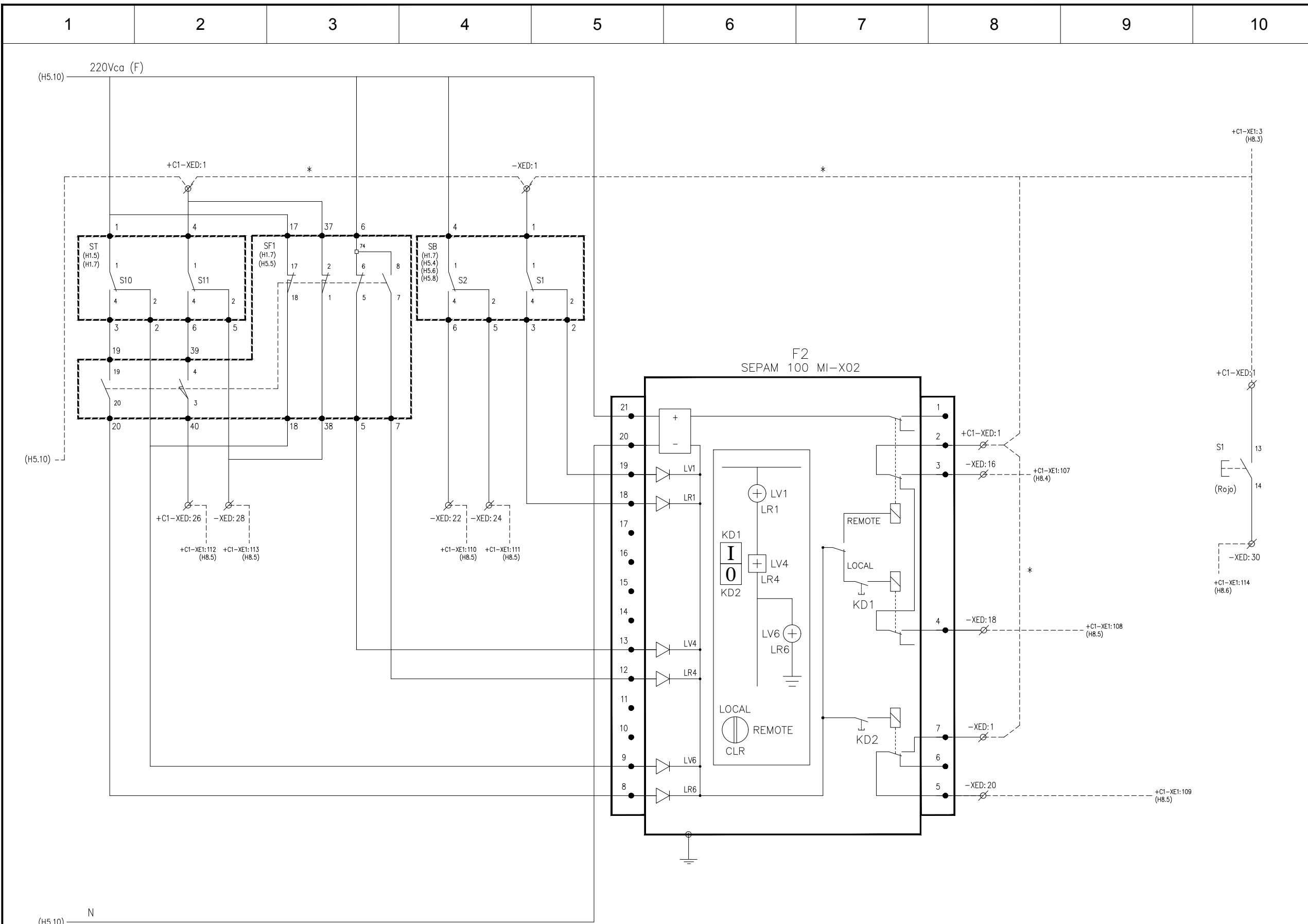

OHARRAK :
NOTAS :

* PUENTEADO EN BORNERO

ESTADO SECCIONADOR A TIERRA	ESTADO DISYUNTOR	ESTADO SECCIONADOR DE BARRAS	SELECTOR MANUAL LOCAL / REMOTO	SEÑALIZACIÓN CELDA EN REMOTO	ORDEN DE CIERRE	ORDEN DE APERTURA	DESBLOQUEO PLC
-----------------------------	------------------	------------------------------	--------------------------------	------------------------------	-----------------	-------------------	----------------

+A1.C1 ESTADO DISYUNTOR, SECCIONADORES Y RELÉ DE SÍMBOLO Y MANDO TIPO SEPAM 100-MI-X02 (CONTROL DE MANDO)

REV.	PRIMERA EMISIÓN	MAR. 23	IAA	ETS
REV.	CLASE DE MODIFICACION	FECHA	NOMBRE	COMP. OBRA
BERRIKUSPENAK / REVISIONES				
AHOLKULARIA / CONSULTOR		INGENIARI EGILEA INGENIERO AUTOR		
AHOLKULARIAREN ERREFERENTZIA REFERENCIA CONSULTOR		ERREFERENTZIA REFERENCIA		
TTE-IS-23001-DRW-0106		2RVA-IE-22-106-A		

OHARRAK :
NOTAS :

* PUENTEADO EN BORNERO

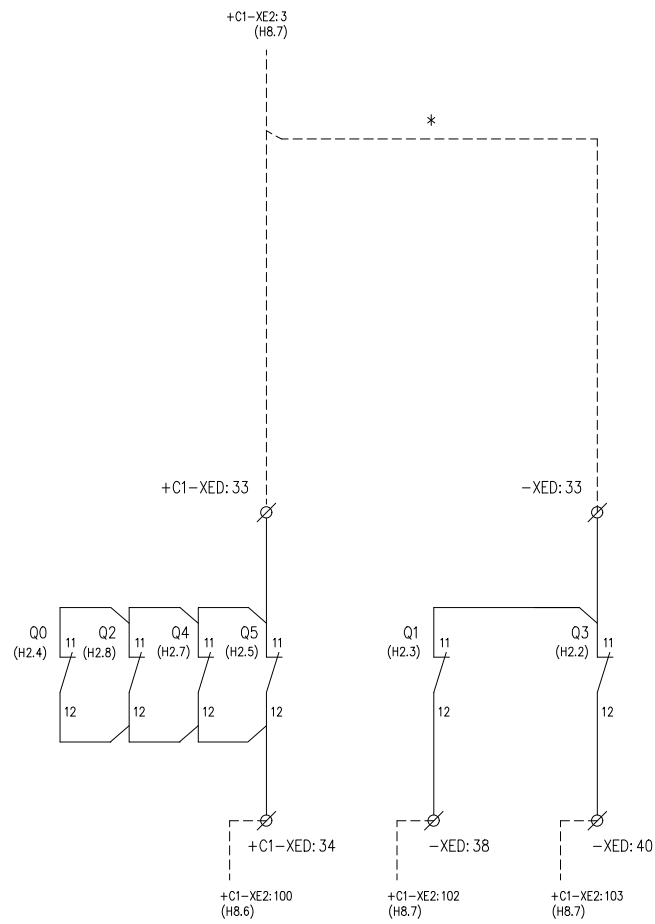

INTERRUPTOR MAGNETOTÉRMICO ABIERTO	PROTECCIÓN ALIMENTACIÓN PLC ABIERTA	PROTECCIÓN ALIMENTACIÓN CTRL. ABIERTA
--	---	---

+A1.C1 CONTACTOS AUXILIARES

REV.	CLASE DE MODIFICACION	FECHA	NOMBRE	COMP.	OBRA
A	PRIMERA EMISIÓN	MAR. 23	IAA	ETS	
BERRIKUSPENAK / REVISIONES					
AHOLKULARIA / CONSULTOR			INGENIARI EGILEA INGENIERO AUTOR		
CAF TURNKEY ENGINEERING					
AHOLKULARIAREN ERREFERENTZIA REFERENCIA CONSULTOR			ERREFERENTZIA REFERENCIA		
TTE-IS-23001-DRW-0107			2RVA-IE-22-107-A		

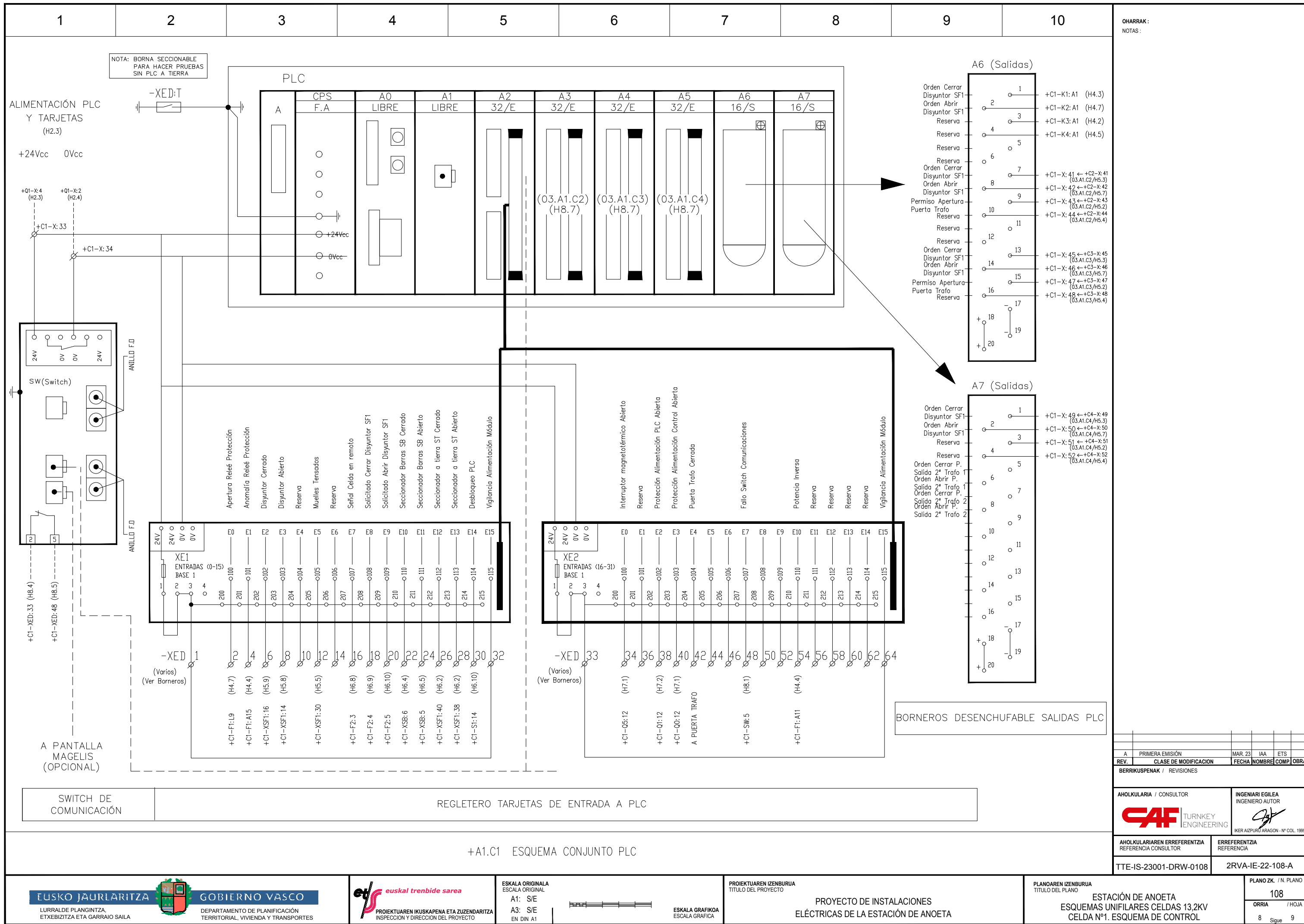

NOTA: BORNA SECCIONABLE PARA HACER PRUEBAS SIN PLC A TIERRA

OHARRAK :
NOTAS :

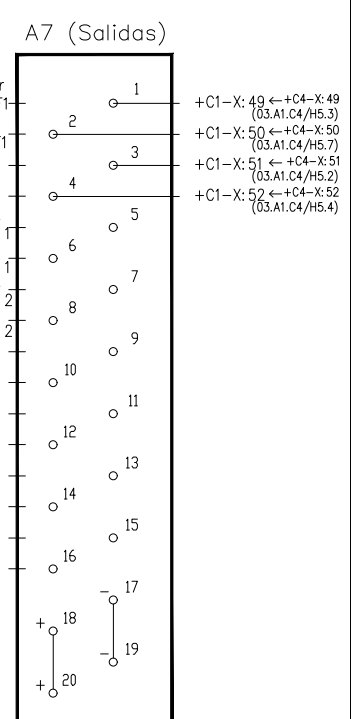
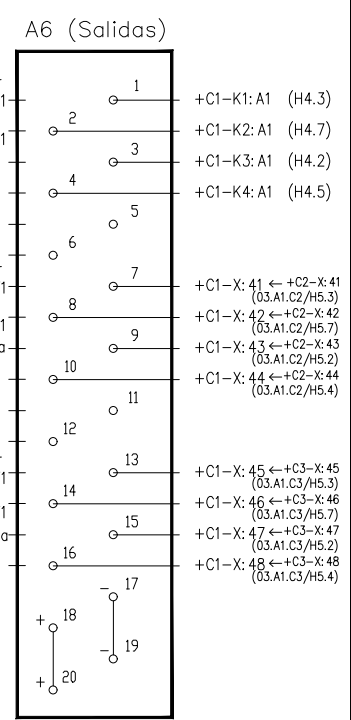

BORNEROS DESENCHUFABLE SALIDAS PLC

A	PRIMERA EMISION	MAR. 23	IAA	ETS
REV.	CLASE DE MODIFICACION	FECHA	NOMBRE	COMP. OBRA
BERRIKUSPENAK / REVISIONES				
AHOLKULARIA / CONSULTOR		INGENIARI EGILEA INGENIERO AUTOR		
CAF TURNKEY ENGINEERING				
AHOLKULARIAREN ERREFERENTZIA REFERENCIA CONSULTOR		ERREFERENTZIA REFERENCIA		
TTE-IS-23001-DRW-0108		2RVA-IE-22-108-A		

+A1.C1 ESQUEMA CONJUNTO PLC

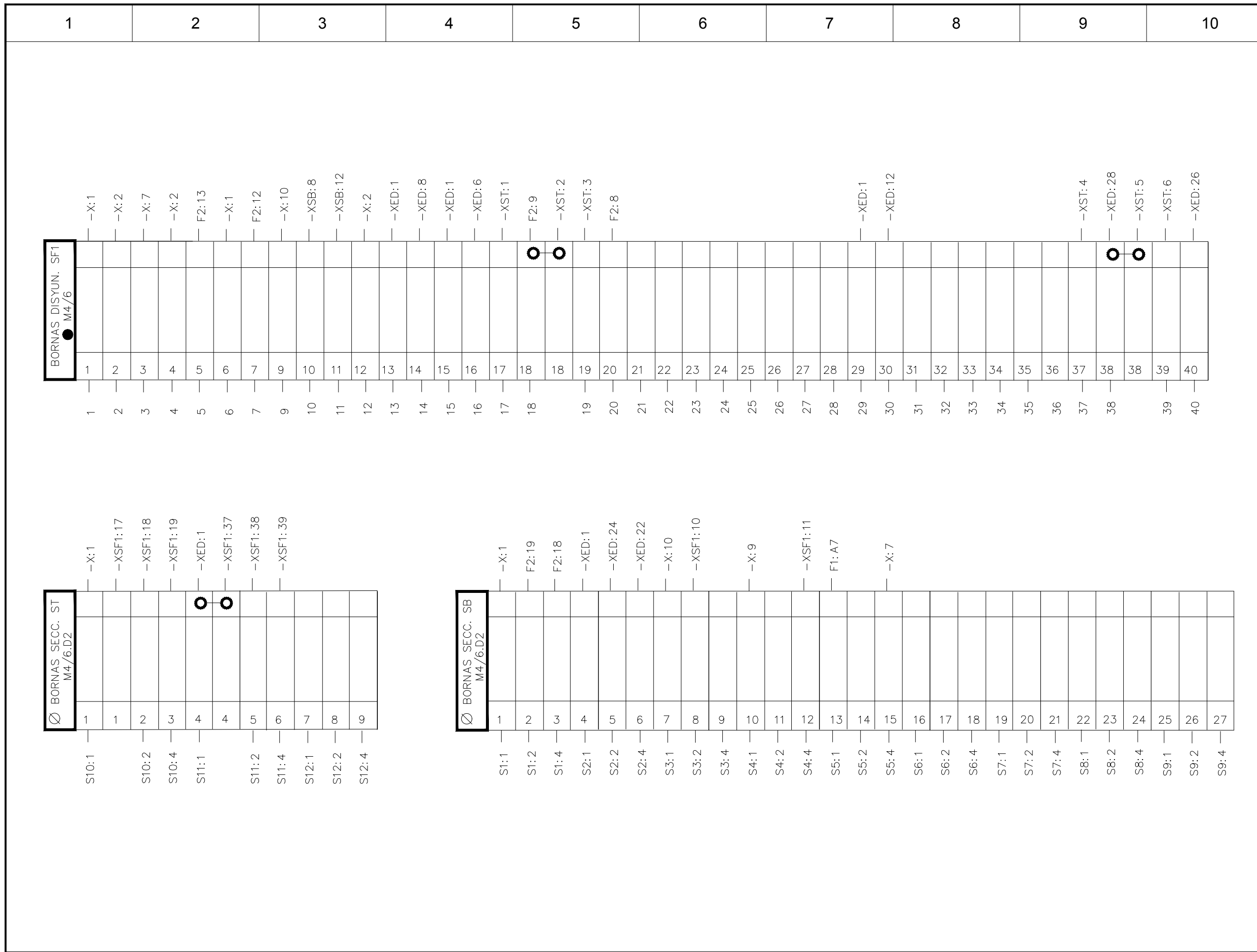

BORNAS DISYUN. SF1
M4/6

BORNAS SECC. ST
M4/6.D2

BORNAS SECC. SB
M4/6.D2

OHARRAK :
NOTAS :

REV.	A	PRIMERA EMISIÓN	MAR. 23	IAA	ETS
REV.		CLASE DE MODIFICACION	FECHA	NOMBRE	COMP. OBRA
BERRIKUSPENAK / REVISIONES					
AHOLKULARIA / CONSULTOR			INGENIARI EGILEA INGENIERO AUTOR		
AHOLKULARIAREN ERREFERENTZIA REFERENCIA CONSULTOR			ERREFERENTZIA REFERENCIA		
TTE-IS-23001-DRW-0109			2RVA-IE-22-109-A		

+A1.C1 BORNEROS DISYUNTOR (SF1) Y SECCIONADOR DE BARRAS (SB) Y A TIERRA (ST)

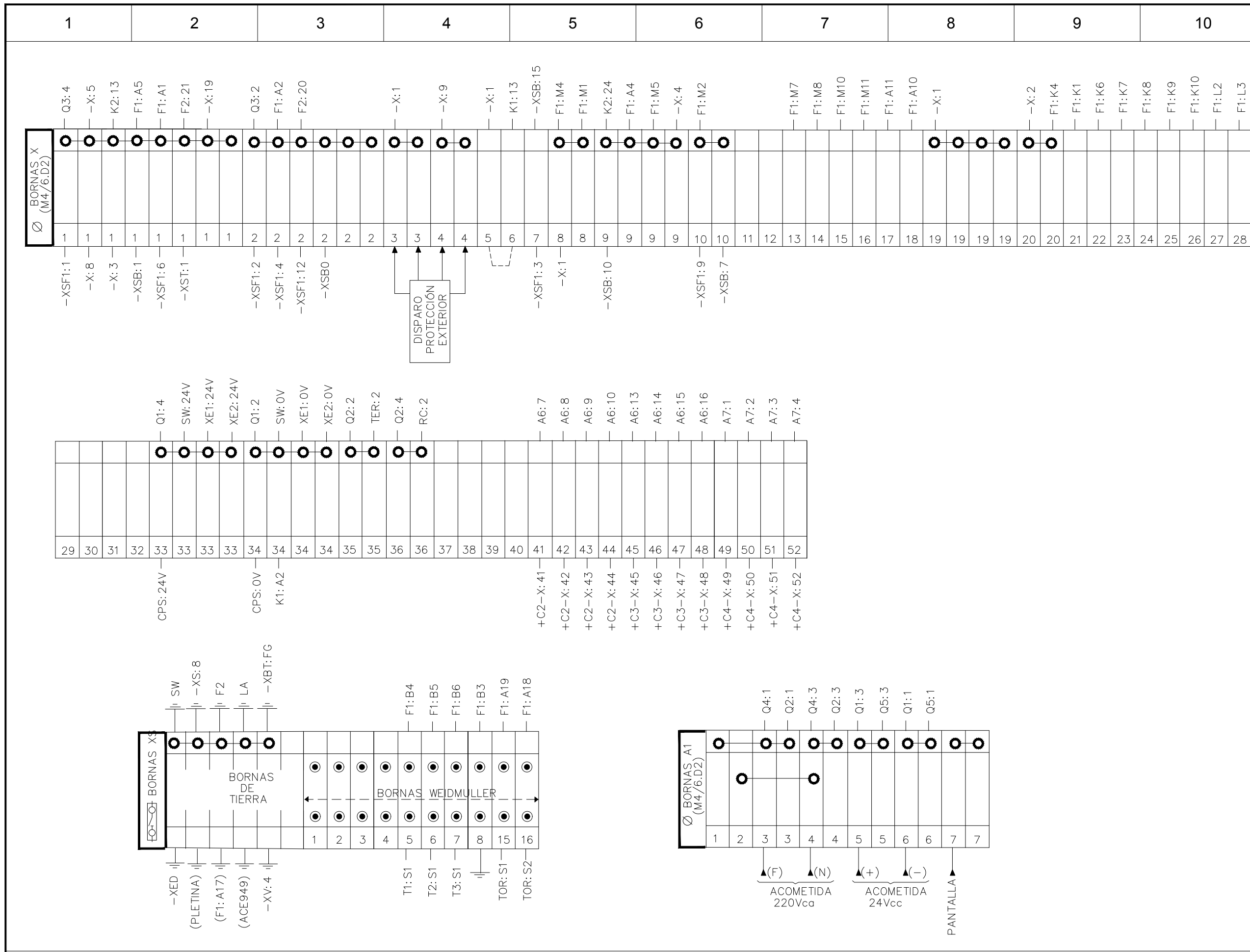

OHARRAK :
NOTAS :

REV.	CLASE DE MODIFICACION	FECHA	NOMBRE	COMP.	OBRA
A	PRIMERA EMISION	MAR. 23	IAA	ETS	
BERRIKUSPENAK / REVISIONES					
AHOLKULARIA / CONSULTOR			INGENIARI EGILEA INGENIERO AUTOR		
AHOLKULARIAREN ERREFERENTZIA REFERENCIA CONSULTOR			ERREFERENTZIA REFERENCIA		
TTE-IS-23001-DRW-0110			2RVA-IE-22-110-A		

+A1.C1 BORNEROS GENERAL, SECCIONABLES (XS) Y DE ACOMETIDA DE FUERZA (A1)

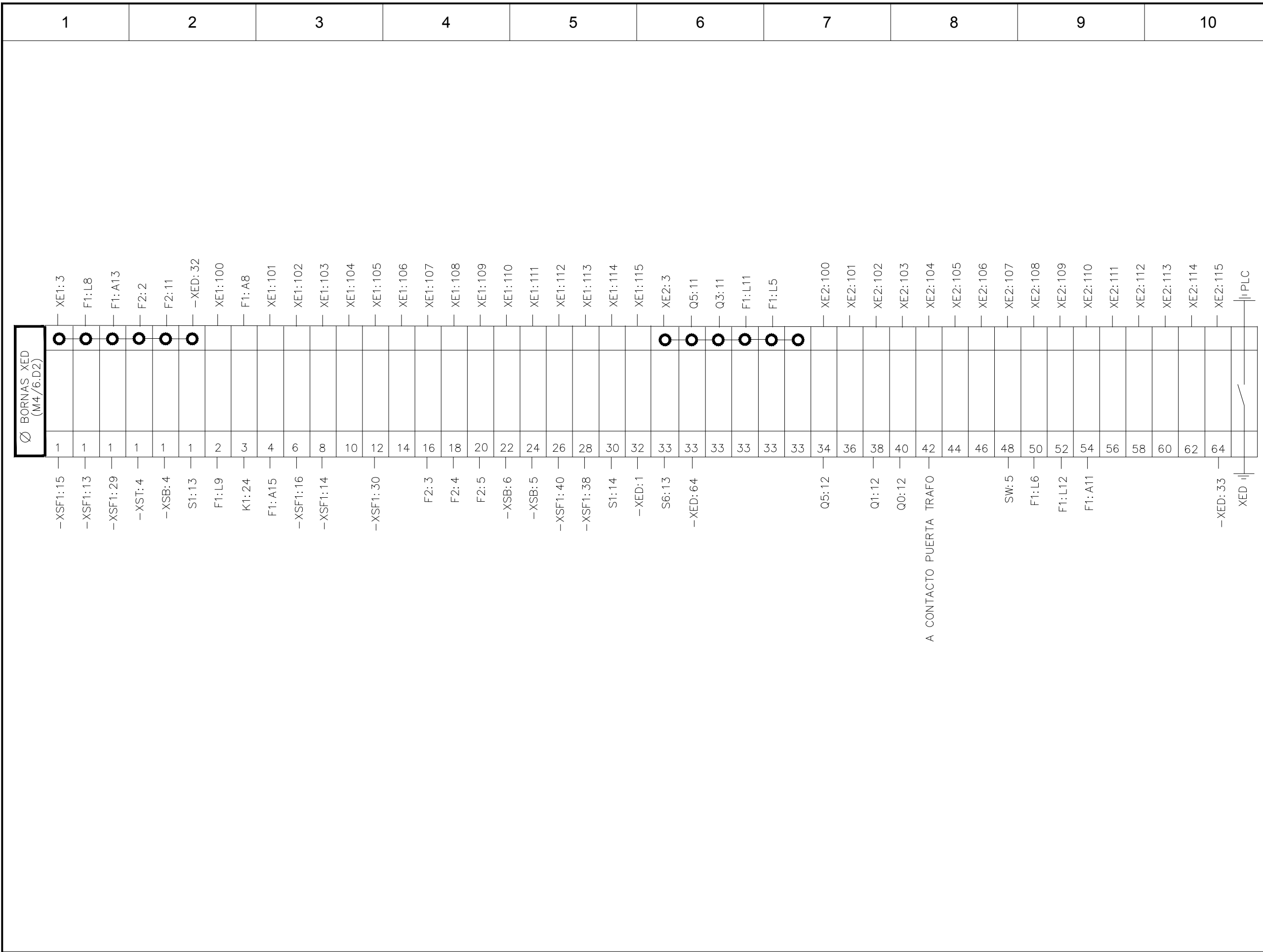

OHARRAK:
NOTAS:

REV.	CLASE DE MODIFICACION	FECHA	NOMBRE	COMP.	OBRA
A	PRIMERA EMISION	MAR. 23	IAA	ETS	

BERRIKUSPENAK / REVISIONES

AHOLKULARIA / CONSULTOR	INGENIARI EGILEA INGENIERO AUTOR
	IKER AIZPURU ARAGON - Nº COL. 1999

AHOLKULARIAREN ERREFERENTZIA REFERENCIA CONSULTOR	ERREFERENTZIA REFERENCIA
--	-----------------------------

TTE-IS-23001-DRW-0111	2RVA-IE-22-111-A
-----------------------	------------------

+A1.C1 BORNERO PARA TARJETAS DE ENTRADA A PLC (XED)

1 2 3 4 5 6 7 8 9 10

OHARRAK :
NOTAS :

APARATOS EN PUERTA

APARATOS EN CAJÓN B.T.

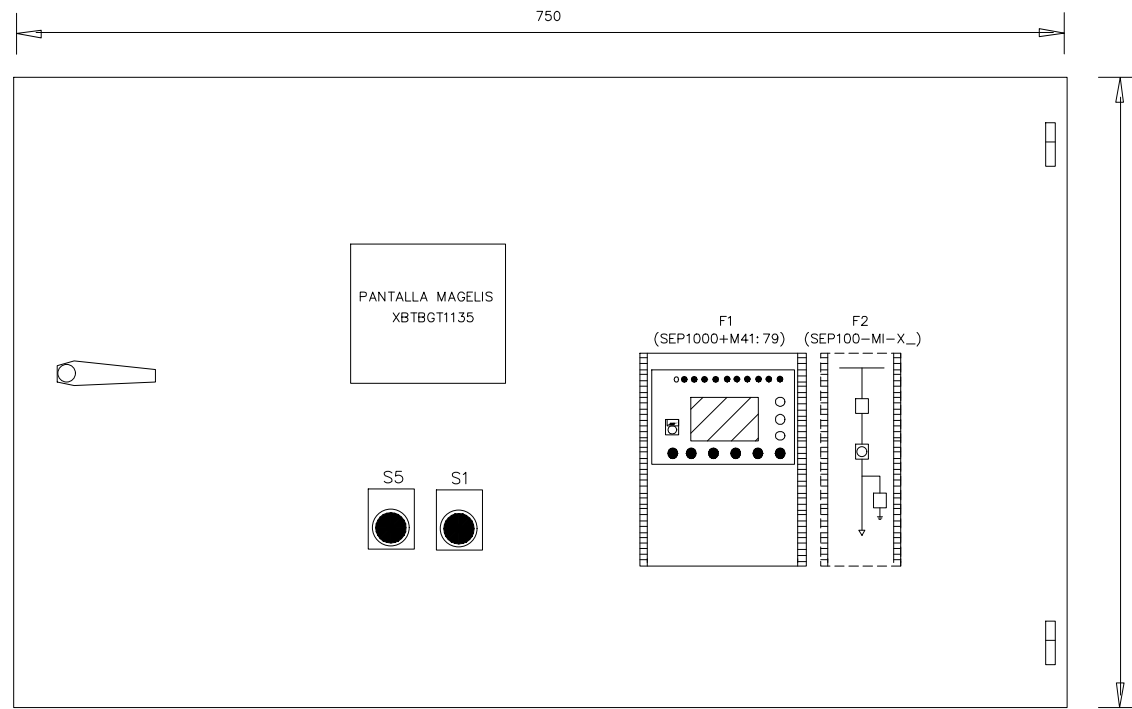

LA
(LÁMPARA EN TECHO DE CAJÓN)

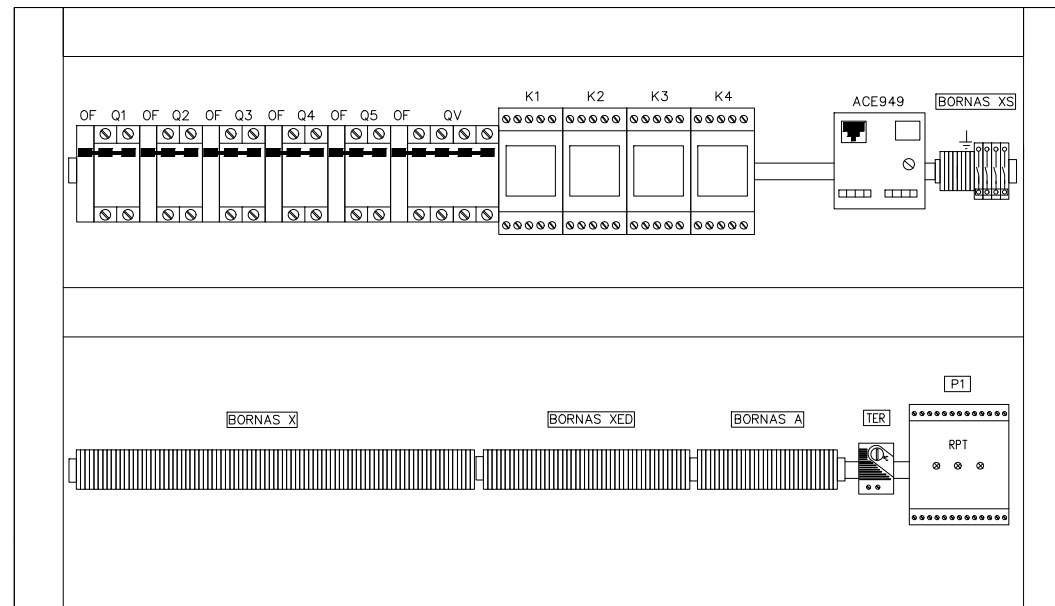

LATERAL IZQUIERDO CAJÓN

LATERAL DERECHO CAJÓN

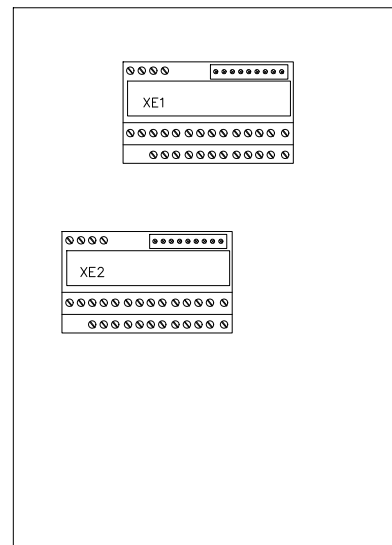
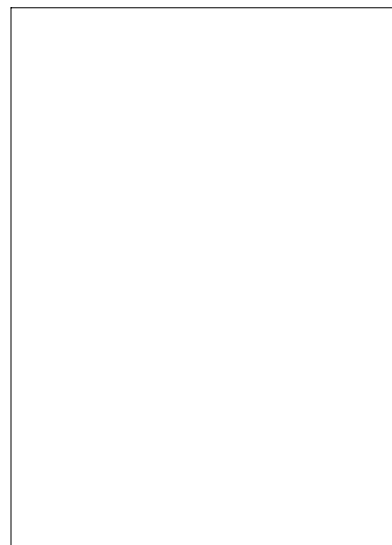

APARATOS EN COMPARTIMENTO B.T.

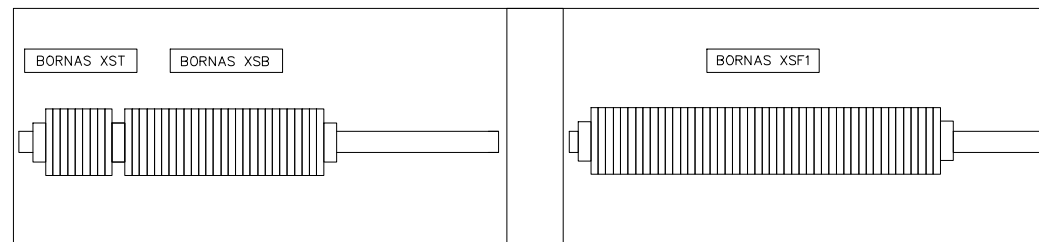

+A1.C1 DISPOSICIÓN FÍSICA DE LOS ELEMENTOS EN CAJÓN DE CELDA

REV.	CLASE DE MODIFICACION	FECHA	NOMBRE	COMP.	OBRA
A	PRIMERA EMISION	MAR. 23	IAA	ETS	

BERRIKUSPENAK / REVISIONES

AHOLKULARIA / CONSULTOR	INGENIARI EGILEA INGENIERO AUTOR
CAF TURNKEY ENGINEERING	
	IKER AIZPURU ARAGON - Nº COL. 1999

AHOLKULARIAREN ERREFERENTZIA REFERENCIA CONSULTOR	ERREFERENTZIA REFERENCIA
--	-----------------------------

TTE-IS-23001-DRW-0112	2RVA-IE-22-112-A
-----------------------	------------------

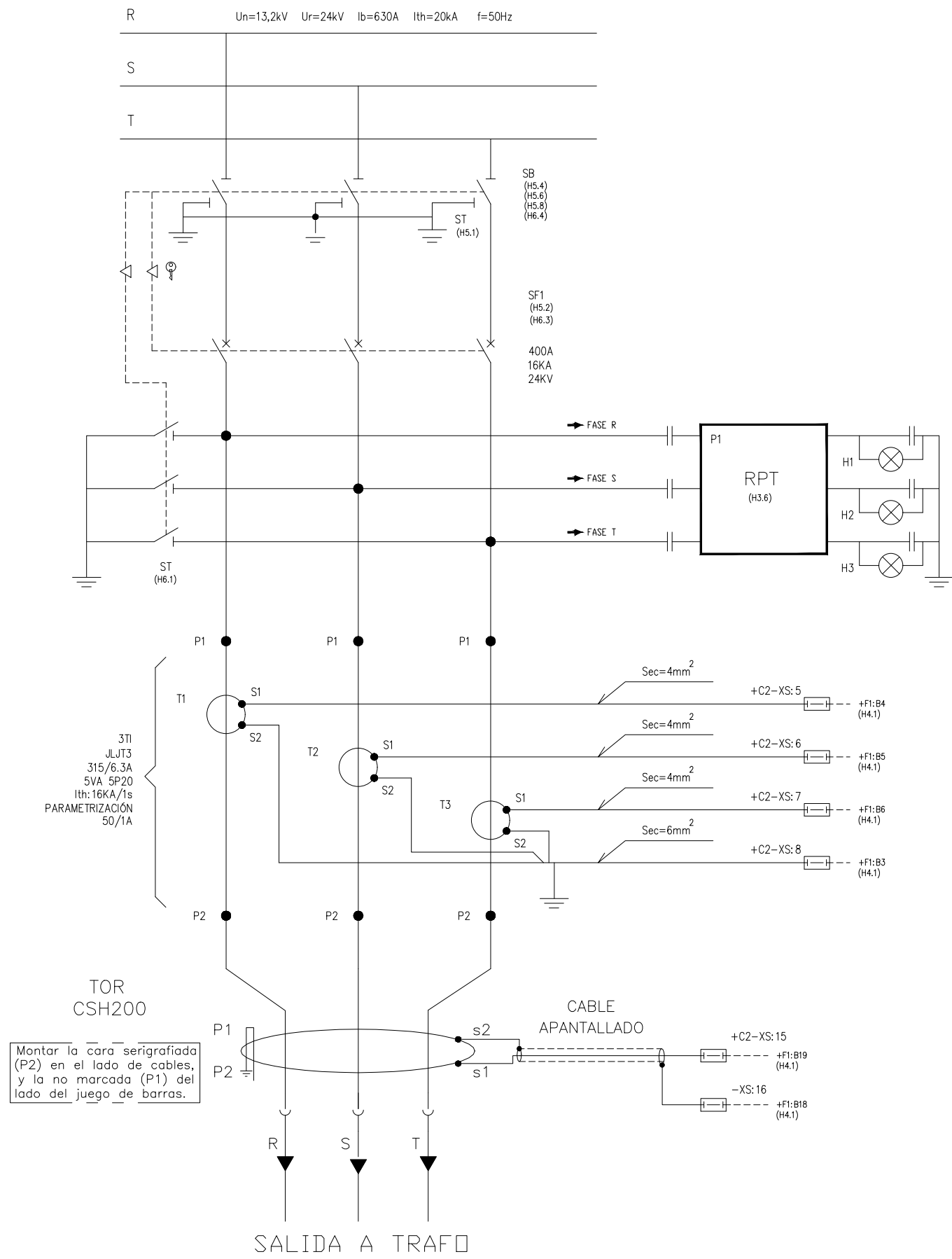

+A1.C2 CIRCUITO DE POTENCIA

REV.	CLASE DE MODIFICACION	FECHA	NOMBRE	COMP.	OBRA
A	PRIMERA EMISION	MAR. 23	IAA	ETS	

BERRIKUSPENAK / REVISIONES

AHOLKULARIA / CONSULTOR	INGENIARI EGILEA INGENIERO AUTOR
CAF TURNKEY ENGINEERING	<i>[Signature]</i>
IKER AIZPURU ARAGON - Nº COL. 1999	

AHOLKULARIAREN ERREFERENTZIA REFERENCIA CONSULTOR	ERREFERENTZIA REFERENCIA
TTE-IS-23001-DRW-0113	2RVA-IE-22-113-A

ACOMETIDA DESDE CABINA ANTERIOR

A CABINA SIGUIENTE

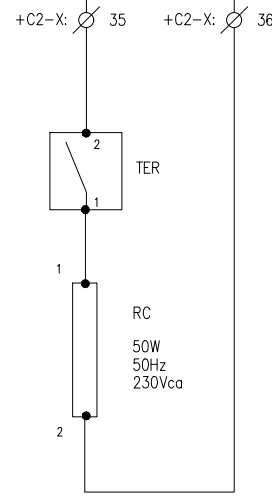
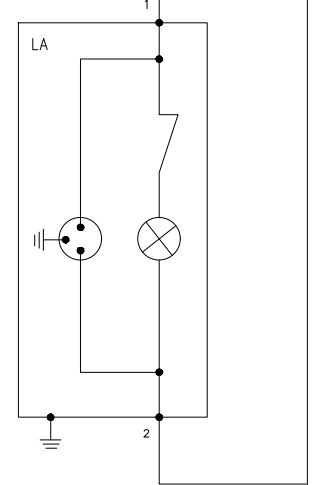
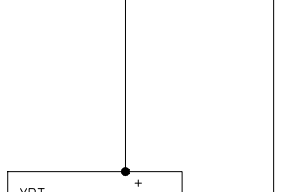
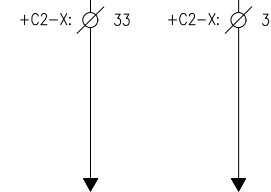
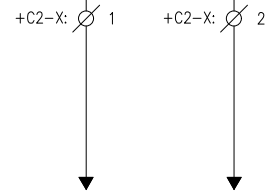
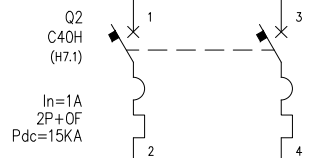
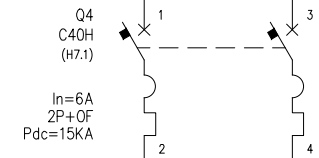
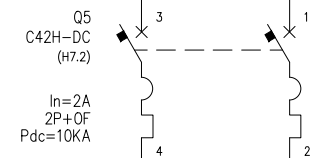
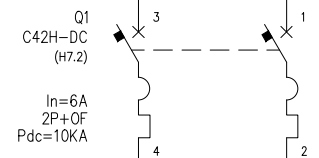
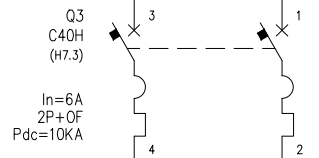
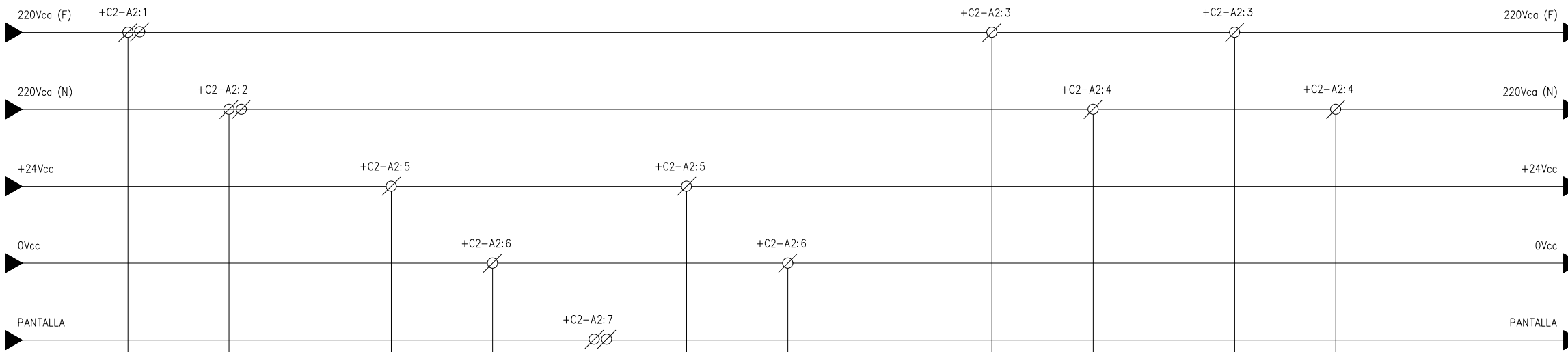

ALIMENTACIÓN CONTROL Y MOTORES (H3.1)

ALIMENTACIÓN PLC Y TARJETAS (H8.1)

+A1.C2 ACOMETIDAS TENSIONES AUXILIARES

REV.	PRIMERA EMISIÓN	MAR. 23	IAA	ETS
	CLASE DE MODIFICACION	FECHA	NOMBRE	COMP. OBRA

BERRIKUSPENAK / REVISIONES

AHOLKULARIA / CONSULTOR: **CAF** TURNKEY ENGINEERING
 INGENIARI EGILEA / INGENIERO AUTOR: *[Signature]*
IKER AZPIURU ARAGON - Nº COL. 1999

AHOLKULARIAREN ERREFERENTZIA / REFERENCIA CONSULTOR	ERREFERENTZIA / REFERENCIA
---	----------------------------

TTE-IS-23001-DRW-0114 2RVA-IE-22-114-A

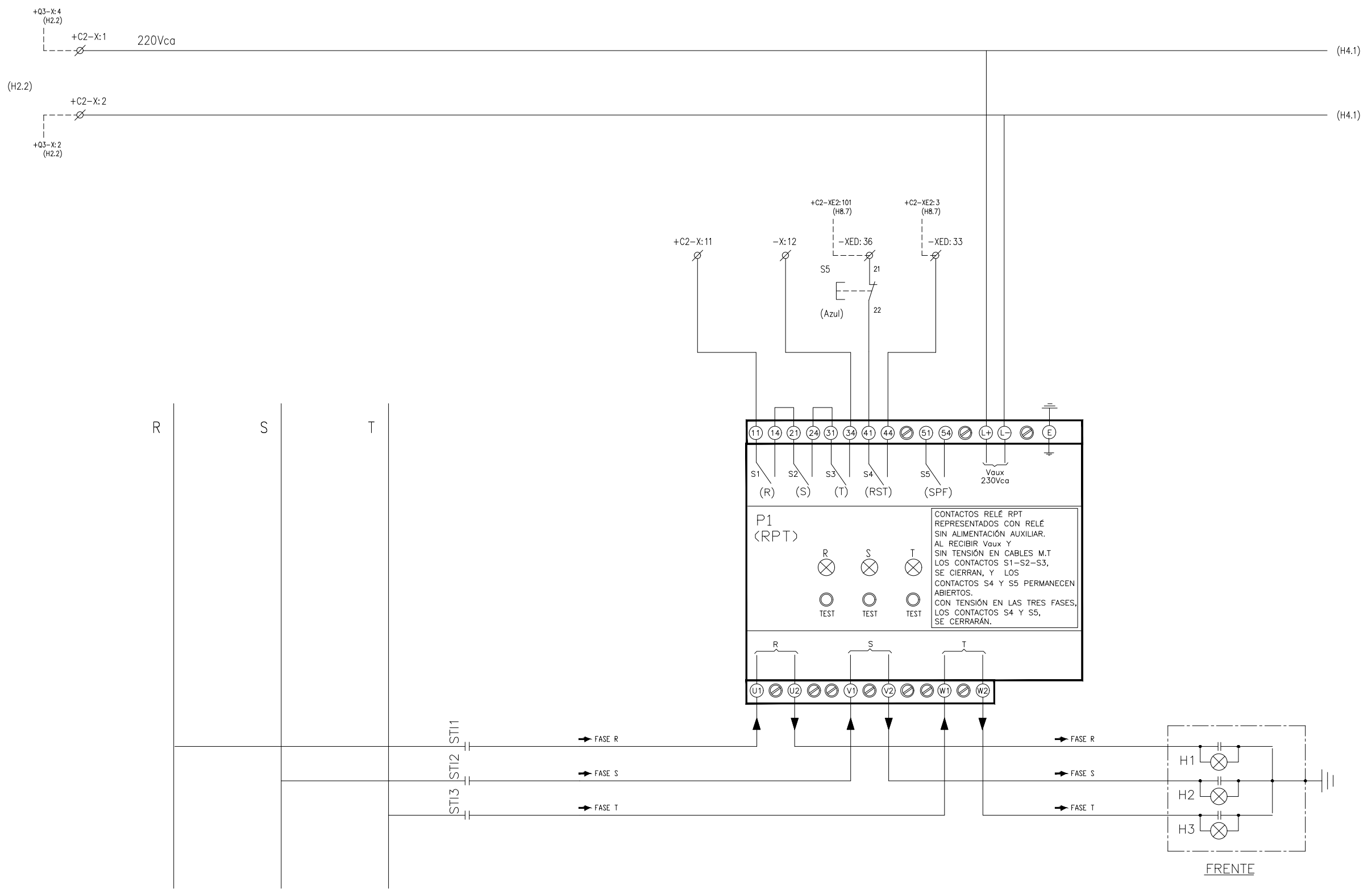

FALTA FASE	PRESENCIA TENSIÓN	PRESENCIA DE TENSIÓN
------------	-------------------	----------------------

+A1.C2 DETALLE RELÉ PRESENCIA DE TENSIÓN (RPT)

REV.	CLASE DE MODIFICACION	FECHA	NOMBRE	COMP.	OBRA
A	PRIMERA EMISION	MAR. 23	IAA	ETS	
BERRIKUSPENAK / REVISIONES					
AHOLKULARIA / CONSULTOR			INGENIARI EGILEA INGENIERO AUTOR		
CAF			TURNKEY ENGINEERING		
AHOLKULARIAREN ERREFERENTZIA REFERENCIA CONSULTOR			ERREFERENTZIA REFERENCIA		
TTE-IS-23001-DRW-0115			2RVA-IE-22-115-A		

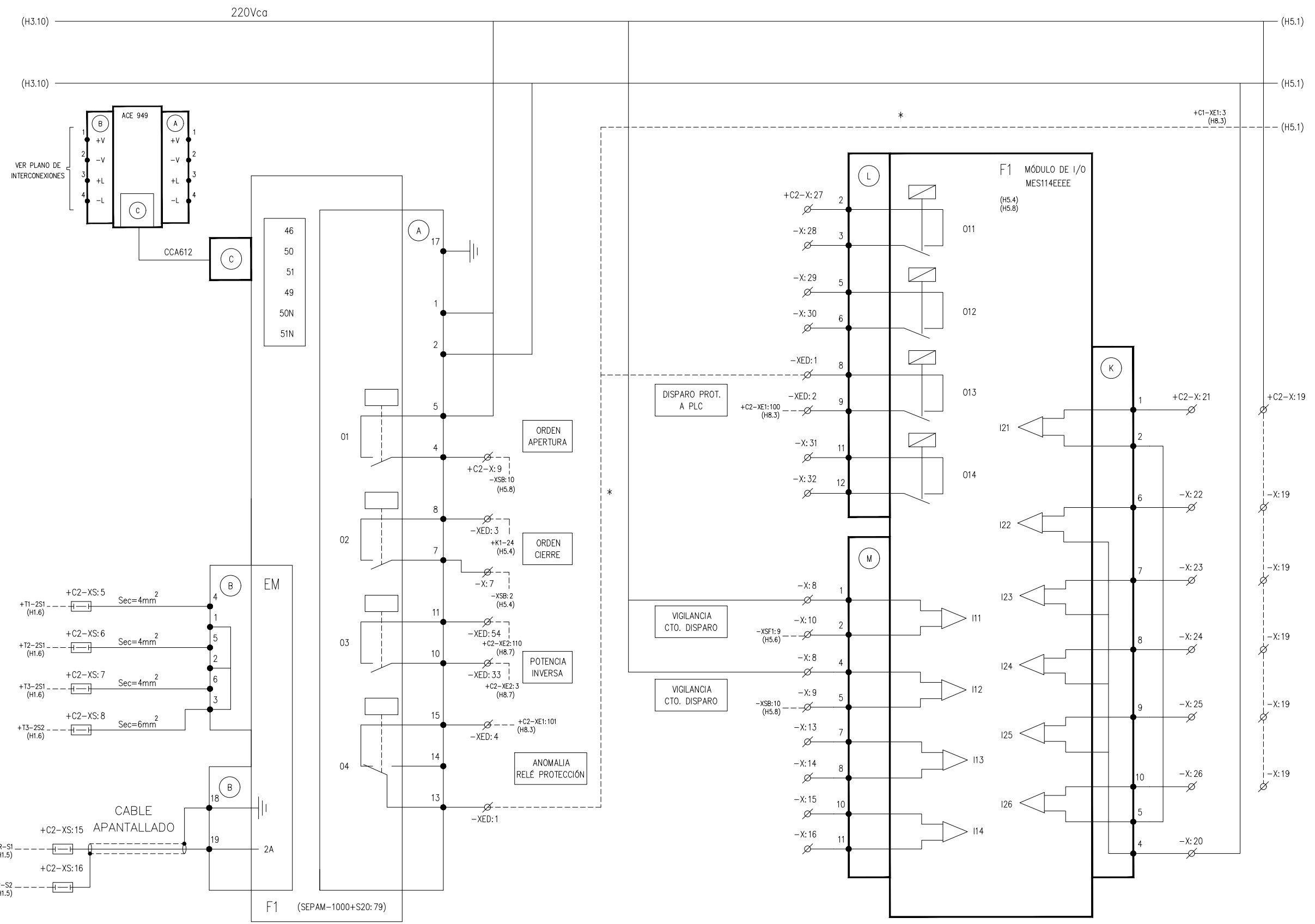

RELÉ PROTECCIÓN TIPO SEPAM-1000 E INTERFACE COMUNICACIÓN CON PLC ACE949

MÓDULO DE ENTRADAS / SALIDAS ADICIONALES PARA SEPAM 1000 EN Vcc

+A1.C2 DETALLE RELÉ DE PROTECCIÓN SEPAM-1000 SERIE 20

REV.	A	PRIMERA EMISIÓN	MAR. 23	IAA	ETS
REV.		CLASE DE MODIFICACION	FECHA	NOMBRE	COMP. OBRA
BERRIKUSPENAK / REVISIONES					
AHOLKULARIA / CONSULTOR			INGENIARI EGILEA INGENIERO AUTOR		
AHOLKULARIAREN ERREFERENTZIA REFERENCIA CONSULTOR			ERREFERENTZIA REFERENCIA		
TTE-IS-23001-DRW-0116			2RVA-IE-22-116-A		

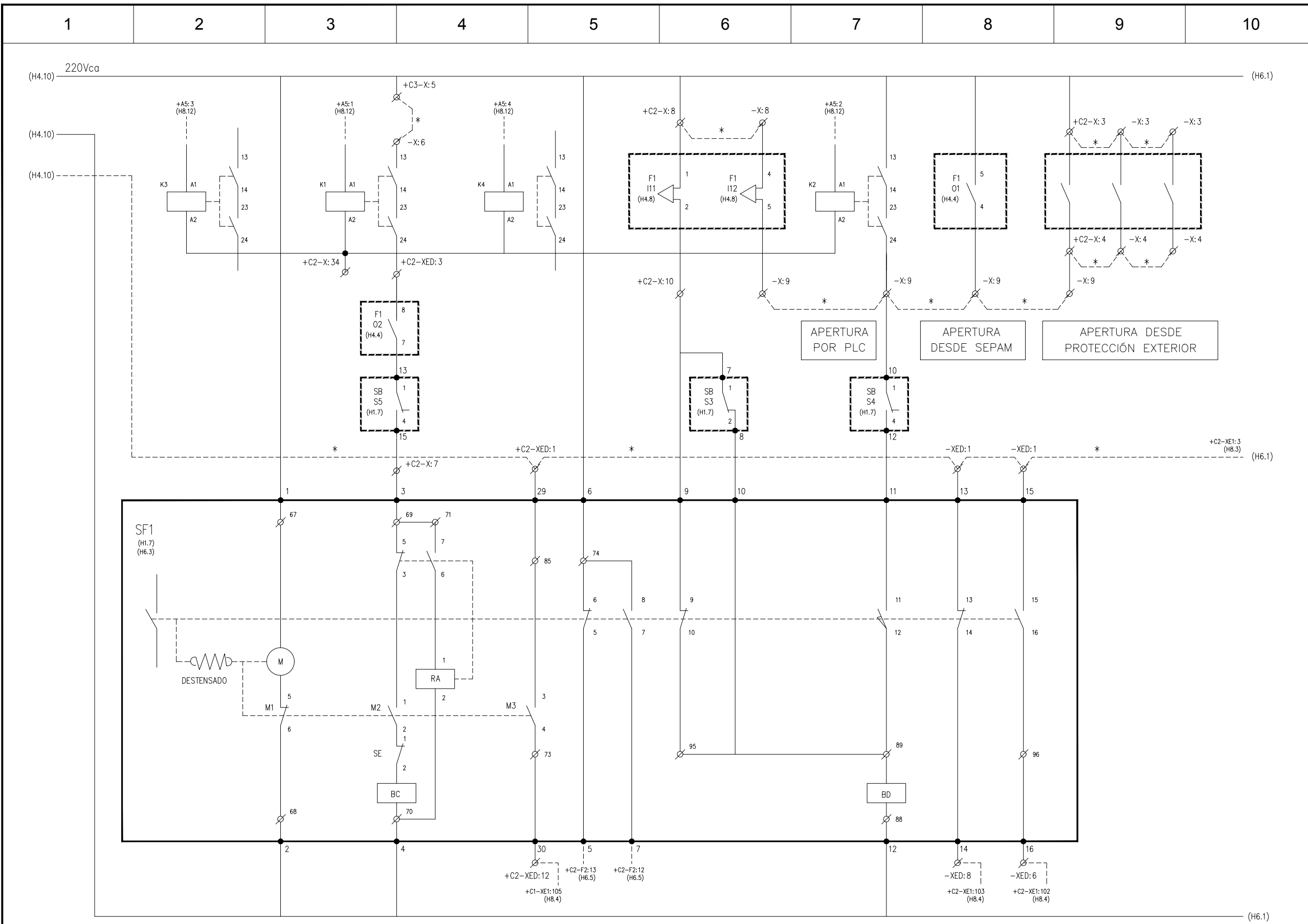

OHARRAK :
NOTAS :

MOTOR	CIERRE Y ENCLAVAMIENTO	MUELLES TENSADOS	ESTADO DISYUNTOR	VIGILANCIA CIRCUITO DISPARO	APERTURA	DISYUNTOR
						ABIERTO CERRADO

+A1.C2 DETALLE DISYUNTOR SF1

REV.	A	PRIMERA EMISION	MAR. 23	IAA	ETS
REV.		CLASE DE MODIFICACION	FECHA	NOMBRE	COMP. OBRA
BERRIKUSPENAK / REVISIONES					
AHOLKULARIA / CONSULTOR			INGENIARI EGILEA INGENIERO AUTOR		
CAF			TURNKEY ENGINEERING		
AHOLKULARIAREN ERREFERENTZIA REFERENCIA CONSULTOR			ERREFERENTZIA REFERENCIA		
TTE-IS-23001-DRW-0117			2RVA-IE-22-117-A		

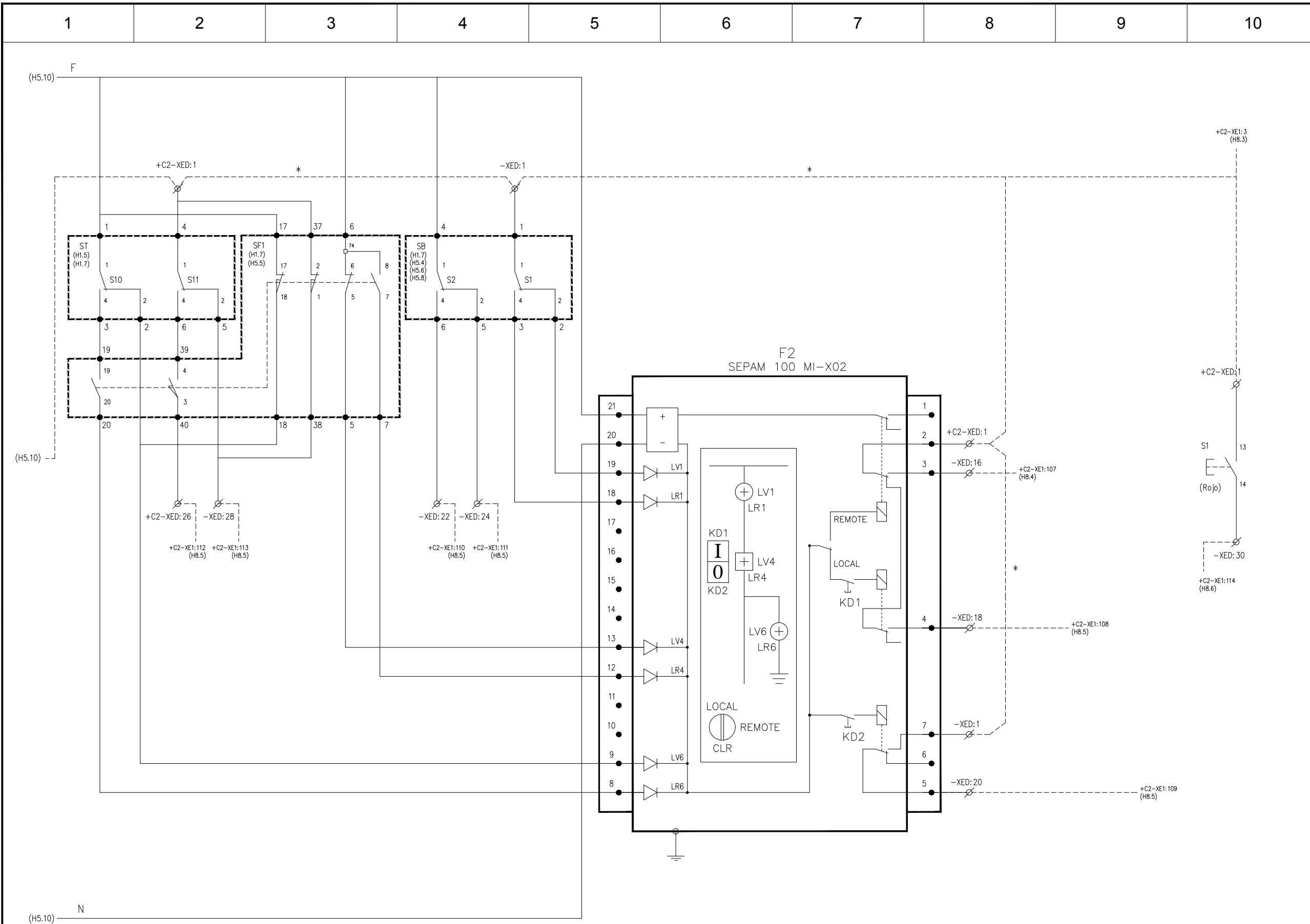

OHARRAK :
NOTAS :

ESTADO SECCIONADOR A TIERRA	ESTADO DISYUNTOR	ESTADO SECCIONADOR DE BARRAS	SELECTOR MANUAL LOCAL / REMOTO	SEÑALIZACIÓN CELDA EN REMOTO	ORDEN DE CIERRE	ORDEN DE APERTURA	DESBLOQUEO PLC
-----------------------------	------------------	------------------------------	--------------------------------	------------------------------	-----------------	-------------------	----------------

+A1.C2 ESTADO DISYUNTOR, SECCIONADORES Y RELÉ DE SÍMBOLO Y MANDO TIPO SEPAM 100-MI-X02 (CONTROL DE MANDO)

REV.	PRIMERA EMISIÓN	MAR. 23	IAA	ETS
REV.	CLASE DE MODIFICACION	FECHA	NOMBRE	COMP. OBRA
BERRIKUSPENAK / REVISIONES				
AHOLKULARIA / CONSULTOR		INGENIARI EGILEA INGENIERO AUTOR		
AHOLKULARIAREN ERREFERENTZIA REFERENCIA CONSULTOR		ERREFERENTZIA REFERENCIA		
TTE-IS-23001-DRW-0118		2RVA-IE-22-118-A		

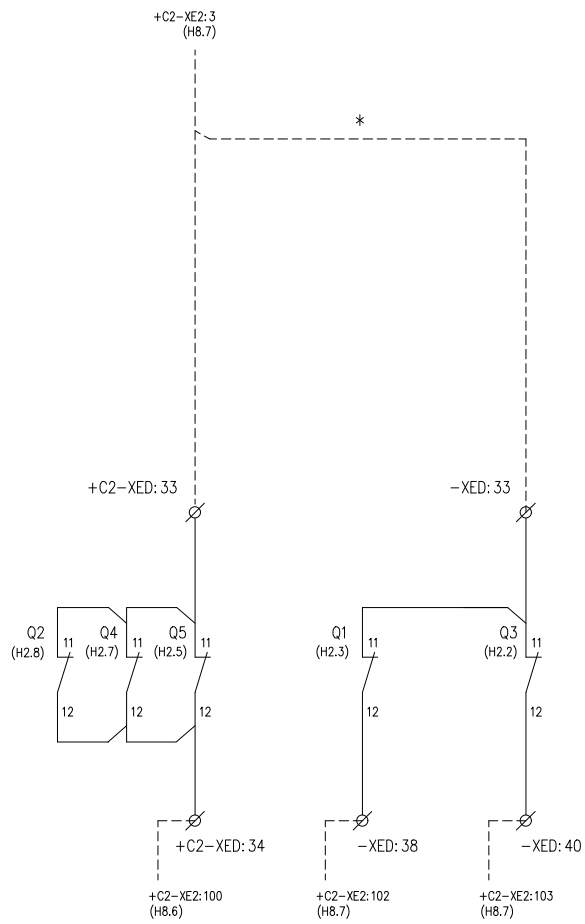

INTERRUPTOR MAGNETOTÉRMICO ABIERTO	PROTECCIÓN ALIMENTACIÓN PLC ABIERTA	PROTECCIÓN ALIMENTACIÓN CTRL. ABIERTA	
--	---	---	--

+A1.C2 CONTACTOS AUXILIARES

A	PRIMERA EMISIÓN	MAR. 23	IAA	ETS	
REV.	CLASE DE MODIFICACION	FECHA	NOMBRE	COMP.	OBRA
BERRIKUSPENAK / REVISIONES					
AHOLKULARIA / CONSULTOR			INGENIARI EGILEA INGENIERO AUTOR		
AHOLKULARIAREN ERREFERENTZIA REFERENCIA CONSULTOR			ERREFERENTZIA REFERENCIA		
TTE-IS-23001-DRW-0119			2RVA-IE-22-119-A		

ALIMENTACIÓN PLC
Y TARJETAS
(H2.3)

+24Vcc 0Vcc

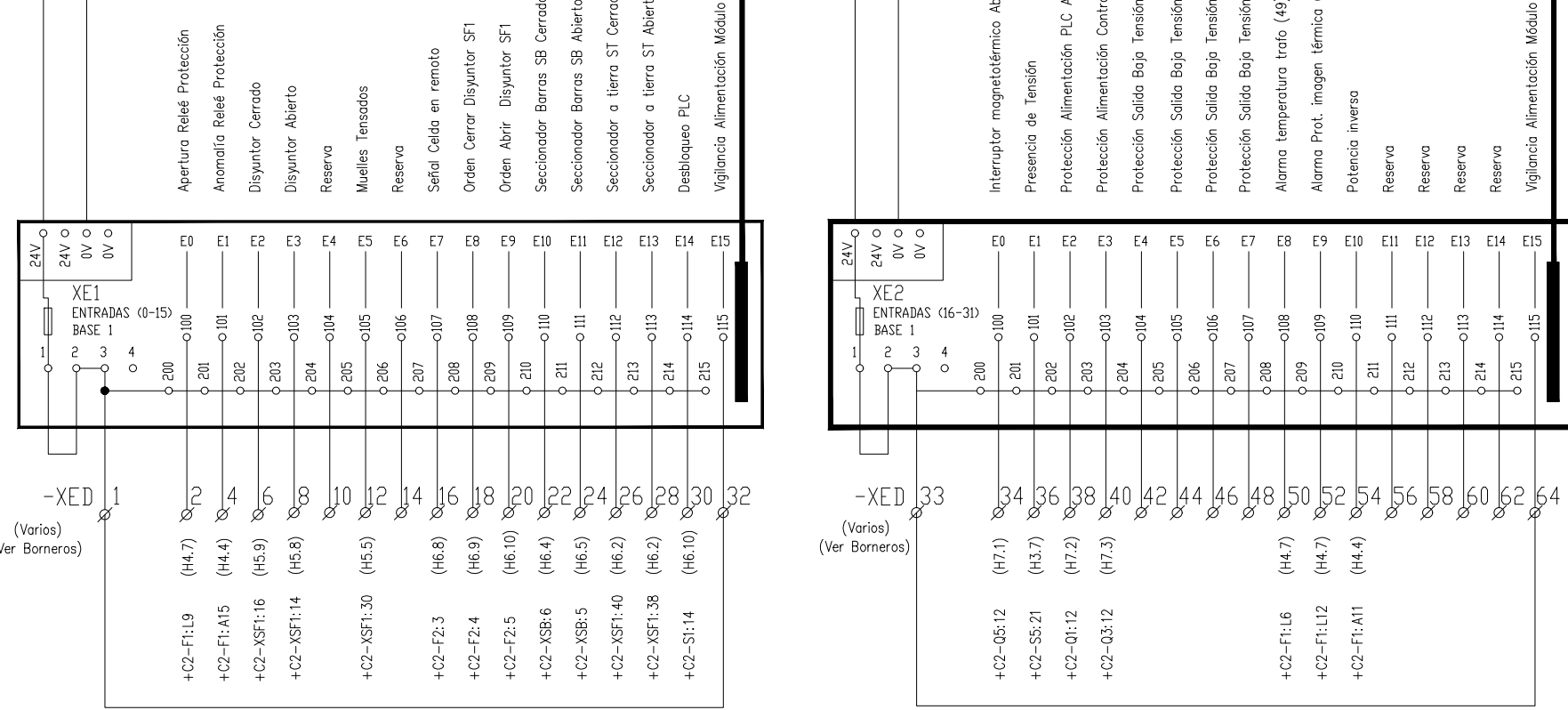
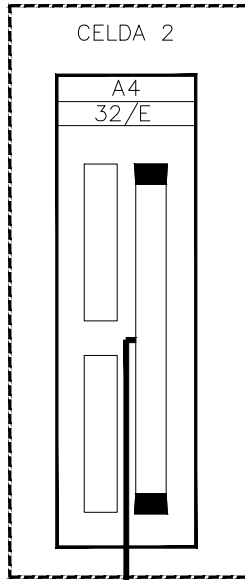
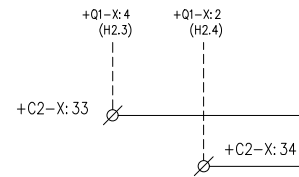

SWITCH DE COMUNICACIÓN

REGLETERO TARJETAS DE ENTRADA A PLC

+A1.C2 ESQUEMA CONJUNTO PLC

REV.	PRIMERA EMISIÓN	MAR. 23	IAA	ETS
	CLASE DE MODIFICACION	FECHA	NOMBRE	COMP. OBRA
BERRIKUSPENAK / REVISIONES				
AHOLKULARIA / CONSULTOR		INGENIARI EGILEA INGENIERO AUTOR		
AHOLKULARIAREN ERREFERENTZIA REFERENCIA CONSULTOR		ERREFERENTZIA REFERENCIA		
TTE-IS-23001-DRW-0120		2RVA-IE-22-120-A		

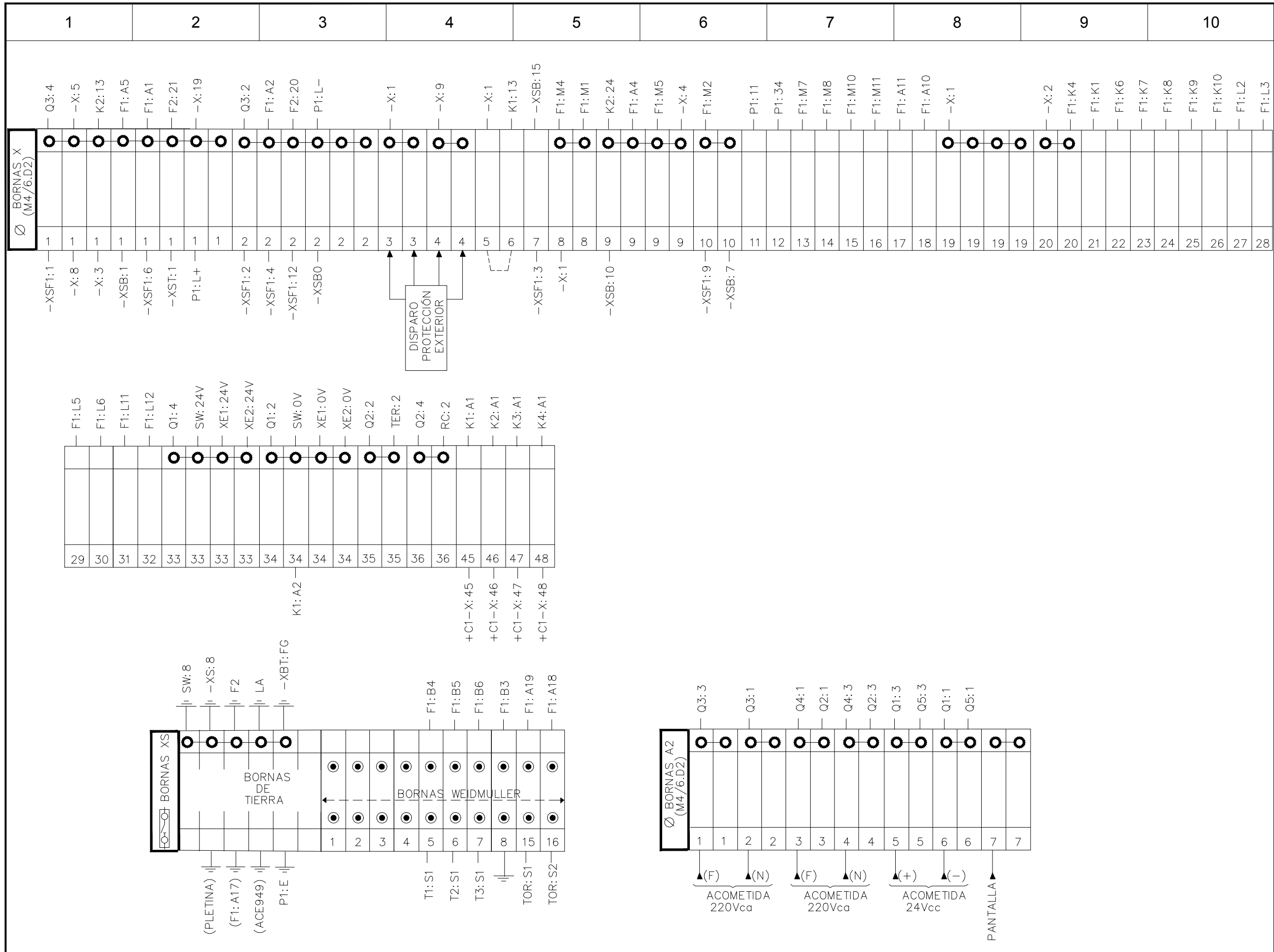

OHARRAK:
NOTAS:

A	PRIMERA EMISIÓN	MAR. 23	IAA	ETS
REV.	CLASE DE MODIFICACION	FECHA	NOMBRE	COMP. OBRA
BERRIKUSPENAK / REVISIONES				
AHOLKULARIA / CONSULTOR		INGENIARI EGILEA INGENIERO AUTOR		
AHOLKULARIAREN ERREFERENTZIA REFERENCIA CONSULTOR		ERREFERENTZIA REFERENCIA		
TTE-IS-23001-DRW-0122		2RVA-IE-22-122-A		

+A1.C2 BORNEROS GENERAL, SECCIONABLES (XS) Y DE ACOMETIDA DE FUERZA (A2)

OHARRAK :
NOTAS :

Ø BORNAS XED (M4/6.D2)	1	-XSF1:15	XE1:3
	1	-XSF1:13	F1:L8
	1	-XSF1:29	F1:A13
	1	-XST:4	F2:2
	1	-XSB:4	F2:11
	1	S1:13	-XED:32
	2	F1:L9	XE1:100
	3	K1:24	F1:A8
	4	F1:A15	XE1:101
	6	-XSF1:16	XE1:102
	8	-XSF1:14	XE1:103
	10		XE1:104
	12	-XSF1:30	XE1:105
	14		XE1:106
	16	F2:3	XE1:107
	18	F2:4	XE1:108
	20	F2:5	XE1:109
	22	-XSB:6	XE1:110
	24	-XSB:5	XE1:111
	26	-XSF1:40	XE1:112
	28	-XSF1:38	XE1:113
	30	S1:14	XE1:114
	32	-XED:1	XE1:115
	33	P1:41	XE2:3
	33	-XED:64	Q5:11
	33		Q3:11
	33		
	34	Q5:12	XE2:100
	36	S5:21	XE2:101
	38	Q1:12	XE2:102
	40	Q3:12	XE2:103
	42		XE2:104
	44		XE2:105
	46		XE2:106
	48		XE2:107
	50	F1:L6	XE2:108
	52	F1:L12	XE2:109
	54		XE2:110
	56		XE2:111
	58		XE2:112
	60		XE2:113
	62		XE2:114
	64	-XED:33	XE2:115

REV.	CLASE DE MODIFICACION	FECHA	NOMBRE	COMP.	OBRA
A	PRIMERA EMISION	MAR. 23	IAA	ETS	

BERRIKUSPENAK / REVISIONES

AHOLKULARIA / CONSULTOR CAF TURNKEY ENGINEERING	INGENIARI EGILEA INGENIERO AUTOR
IKER AIZPURU ARAGON - Nº COL. 1999	

AHOLKULARIAREN ERREFERENTZIA REFERENCIA CONSULTOR	ERREFERENTZIA REFERENCIA
TTE-IS-23001-DRW-0123	2RVA-IE-22-123-A

+A1.C2 BORNERO PARA TARJETAS DE ENTRADA A PLC (XED)

1 2 3 4 5 6 7 8 9 10

OHARRAK :
NOTAS :

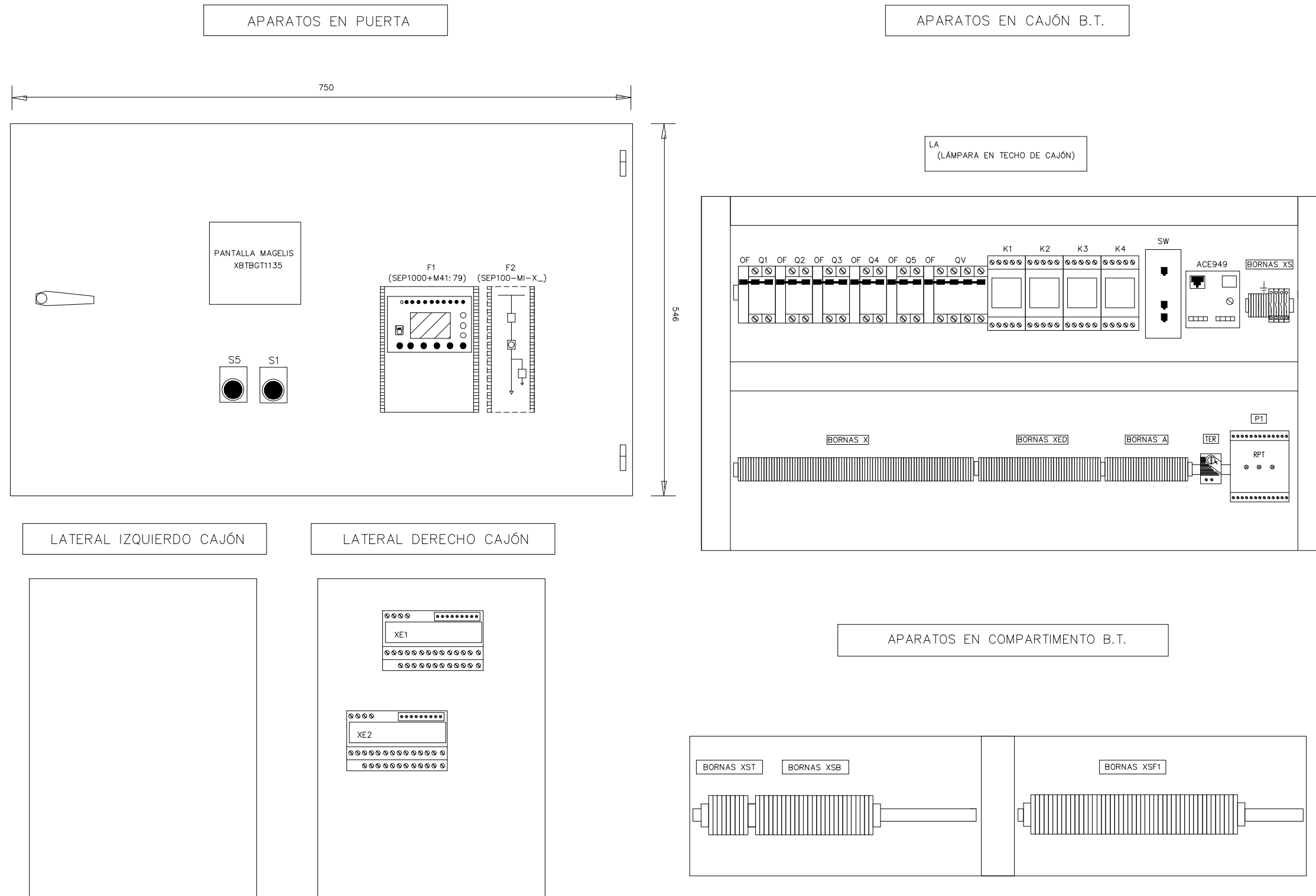

+A1.C2 DISPOSICIÓN FÍSICA DE LOS ELEMENTOS EN CAJÓN DE CELDA

REV.	CLASE DE MODIFICACION	FECHA	NOMBRE	COMP.	OBRA
A	PRIMERA EMISIÓN	MAR. 23	IAA	ETS	

BERRIKUSPENAK / REVISIONES

AHOLKULARIA / CONSULTOR	INGENIARI EGILEA INGENIERO AUTOR
CAF TURNKEY ENGINEERING	
	IKER AIZPURU ARAGON - Nº COL. 1999

AHOLKULARIAREN ERREFERENTZIA REFERENCIA CONSULTOR	ERREFERENTZIA REFERENCIA
TTE-IS-23001-DRW-0124	2RVA-IE-22-124-A

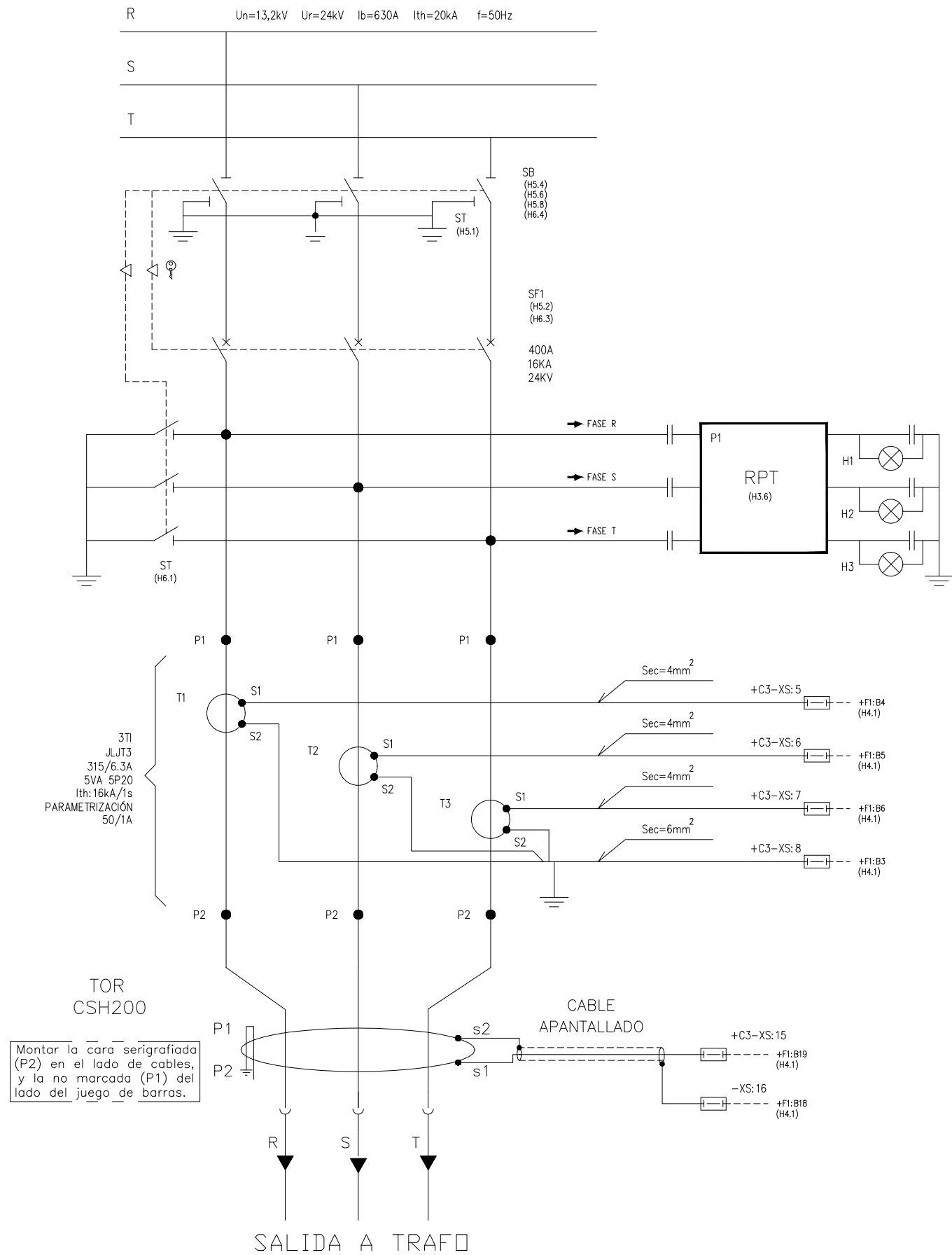

+A1.C3 CIRCUITO DE POTENCIA

REV.	CLASE DE MODIFICACION	FECHA	NOMBRE	COMP.	OBRA
A	PRIMERA EMISION	MAR. 23	IAA	ETS	

BERRIKUSPENAK / REVISIONES

AHOLKULARIA / CONSULTOR	INGENIARI EGILEA INGENIERO AUTOR
CAF TURNKEY ENGINEERING	<i>[Signature]</i>
	IKER AIZPURU ARAGON - Nº COL. 1999

AHOLKULARIAREN ERREFERENTZIA REFERENCIA CONSULTOR	ERREFERENTZIA REFERENCIA
--	-----------------------------

TTE-IS-23001-DRW-0125	2RVA-IE-22-125-A
-----------------------	------------------

ACOMETIDA DESDE CABINA ANTERIOR

A CABINA SIGUIENTE

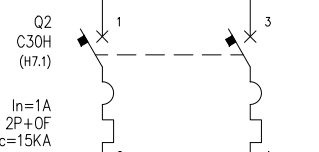
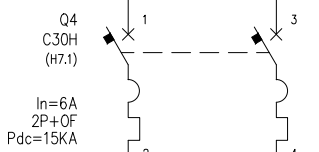
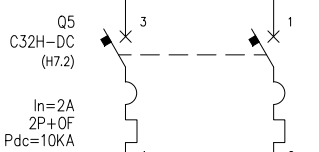
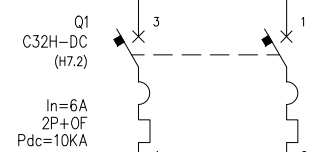
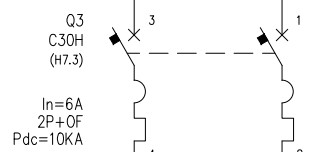
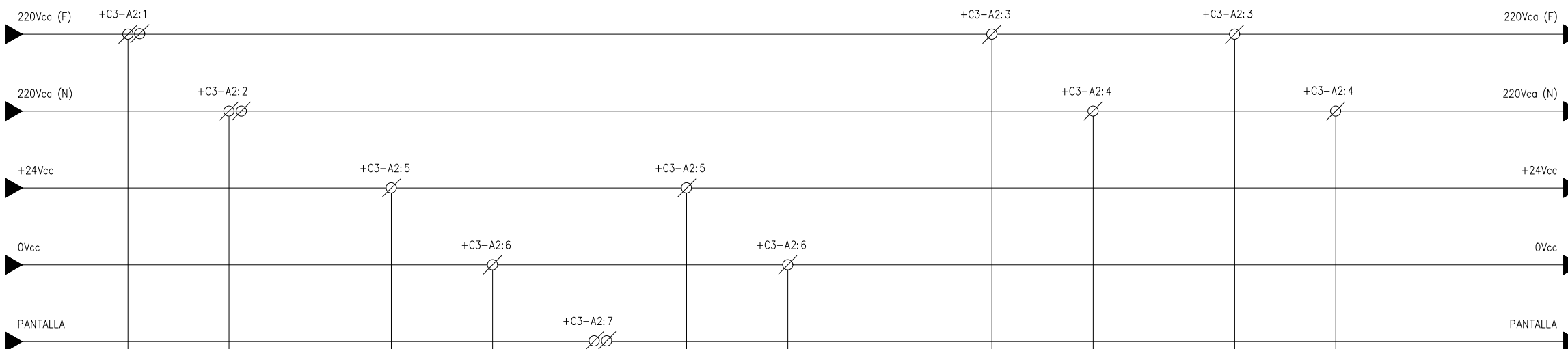

+C3-X: 1 +C3-X: 2

+C3-X: 33 +C3-X: 34

+C3-X: 35 +C3-X: 36

ALIMENTACIÓN CONTROL Y MOTORES (H3.1)

ALIMENTACIÓN PLC Y TARJETAS (H8.1)

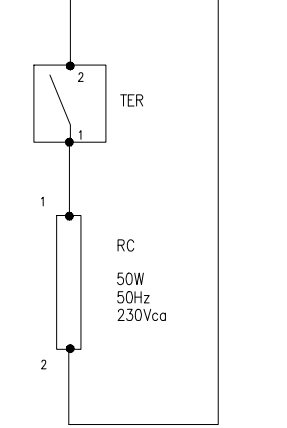
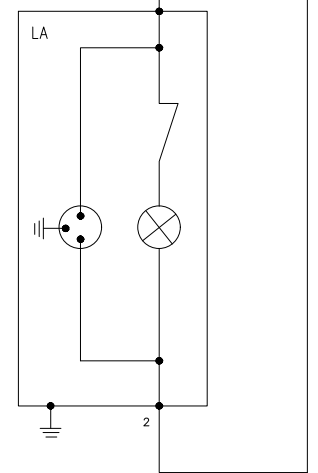
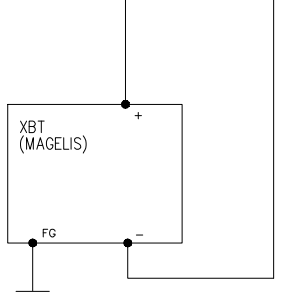

+A1.C3 ACOMETIDAS TENSIONES AUXILIARES

REV.	PRIMERA EMISIÓN	MAR. 23	IAA	ETS
	CLASE DE MODIFICACION	FECHA	NOMBRE	COMP. OBRA

BERRIKUSPENAK / REVISIONES

AHOLKULARIA / CONSULTOR: **CAF** TURNKEY ENGINEERING
 INGENIARI EGILEA / INGENIERO AUTOR: *[Signature]*
IKER AIZPURU ARAGON - Nº COL. 1999

AHOLKULARIAREN ERREFERENTZIA / REFERENCIA CONSULTOR	ERREFERENTZIA / REFERENCIA
---	----------------------------

TTE-IS-23001-DRW-0126 2RVA-IE-22-126-A

OHARRAK :
NOTAS :

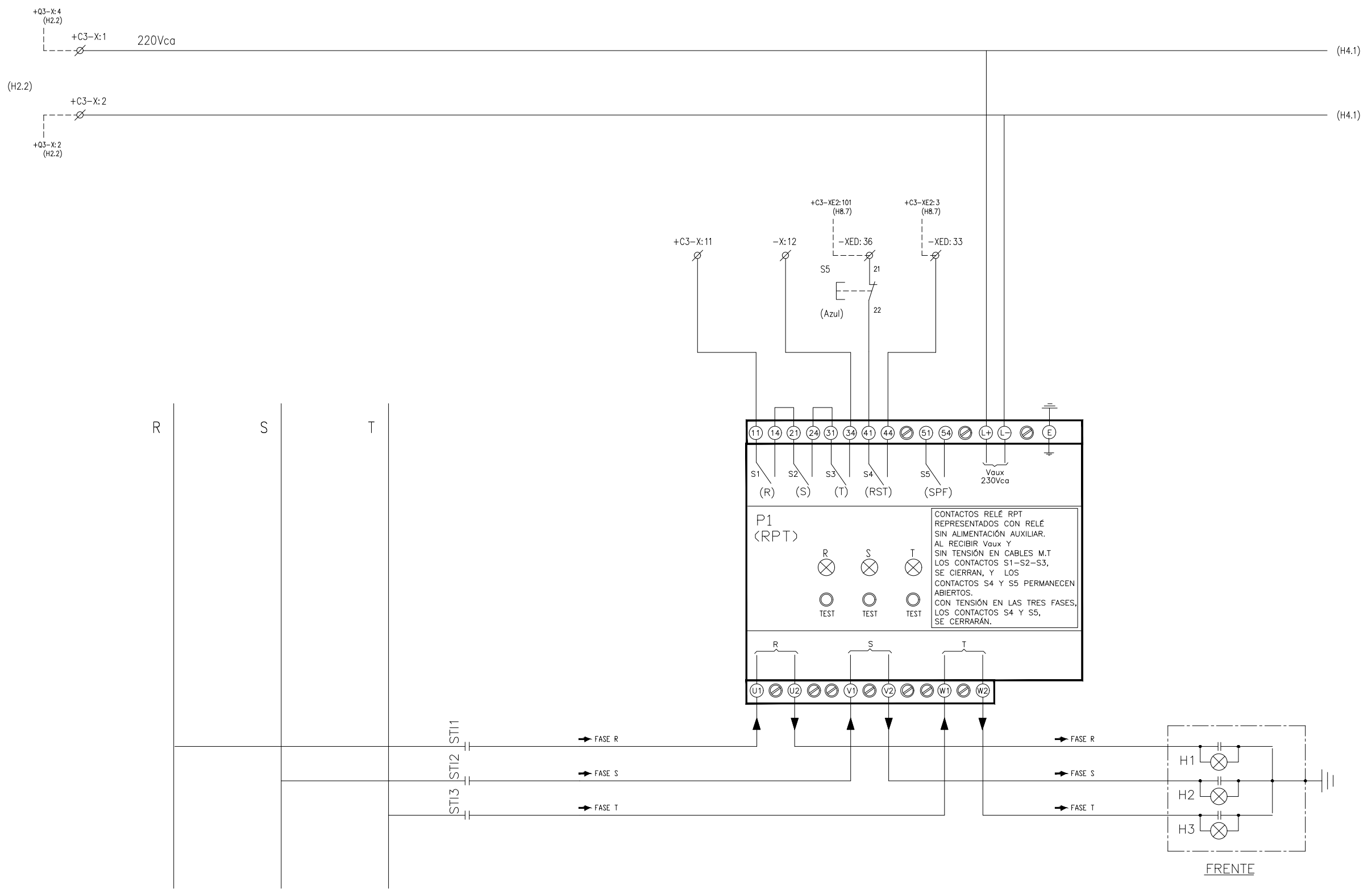

FALTA FASE	PRESENCIA TENSIÓN	PRESENCIA DE TENSIÓN
------------	-------------------	----------------------

+A1.C3 DETALLE RELÉ PRESENCIA DE TENSIÓN (RPT)

REV.	PRIMERA EMISIÓN	MAR. 23	IAA	ETS
	CLASE DE MODIFICACION	FECHA	NOMBRE	COMP. OBRA

BERRIKUSPENAK / REVISIONES

AHOLKULARIA / CONSULTOR	INGENIARI EGILEA INGENIERO AUTOR
CAF TURNKEY ENGINEERING	<i>[Signature]</i>
	IKER AIZPURU ARAGON - Nº COL. 1999

AHOLKULARIAREN ERREFERENTZIA REFERENCIA CONSULTOR	ERREFERENTZIA REFERENCIA
TTE-IS-23001-DRW-0127	2RVA-IE-22-127-A

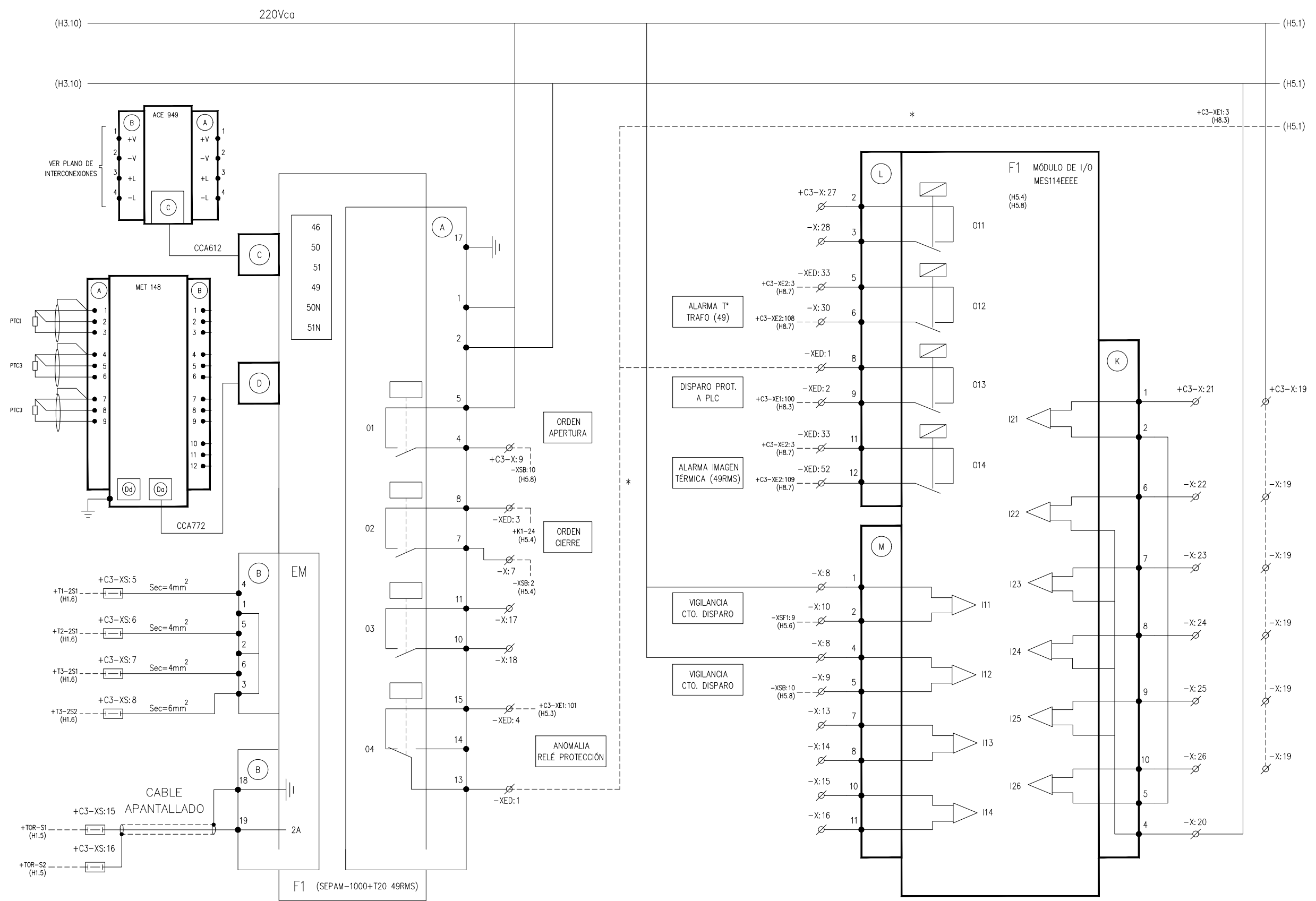

RELÉ PROTECCIÓN TIPO SEPAM-1000 E INTERFACE COMUNICACIÓN CON PLC ACE949

MÓDULO DE ENTRADAS / SALIDAS ADICIONALES PARA SEPAM 1000 EN Vcc

+A1.C3 DETALLE RELÉ DE PROTECCIÓN SEPAM-1000 SERIE 20

REV.	A	PRIMERA EMISIÓN	MAR. 23	IAA	ETS
REV.		CLASE DE MODIFICACION	FECHA	NOMBRE	COMP. OBRA
BERRIKUSPENAK / REVISIONES					
AHOLKULARIA / CONSULTOR			INGENIARI EGILEA INGENIERO AUTOR		
CAF			TURNKEY ENGINEERING		
AHOLKULARIAREN ERREFERENTZIA REFERENCIA CONSULTOR			ERREFERENTZIA REFERENCIA		
TTE-IS-23001-DRW-0128			2RVA-IE-22-128-A		

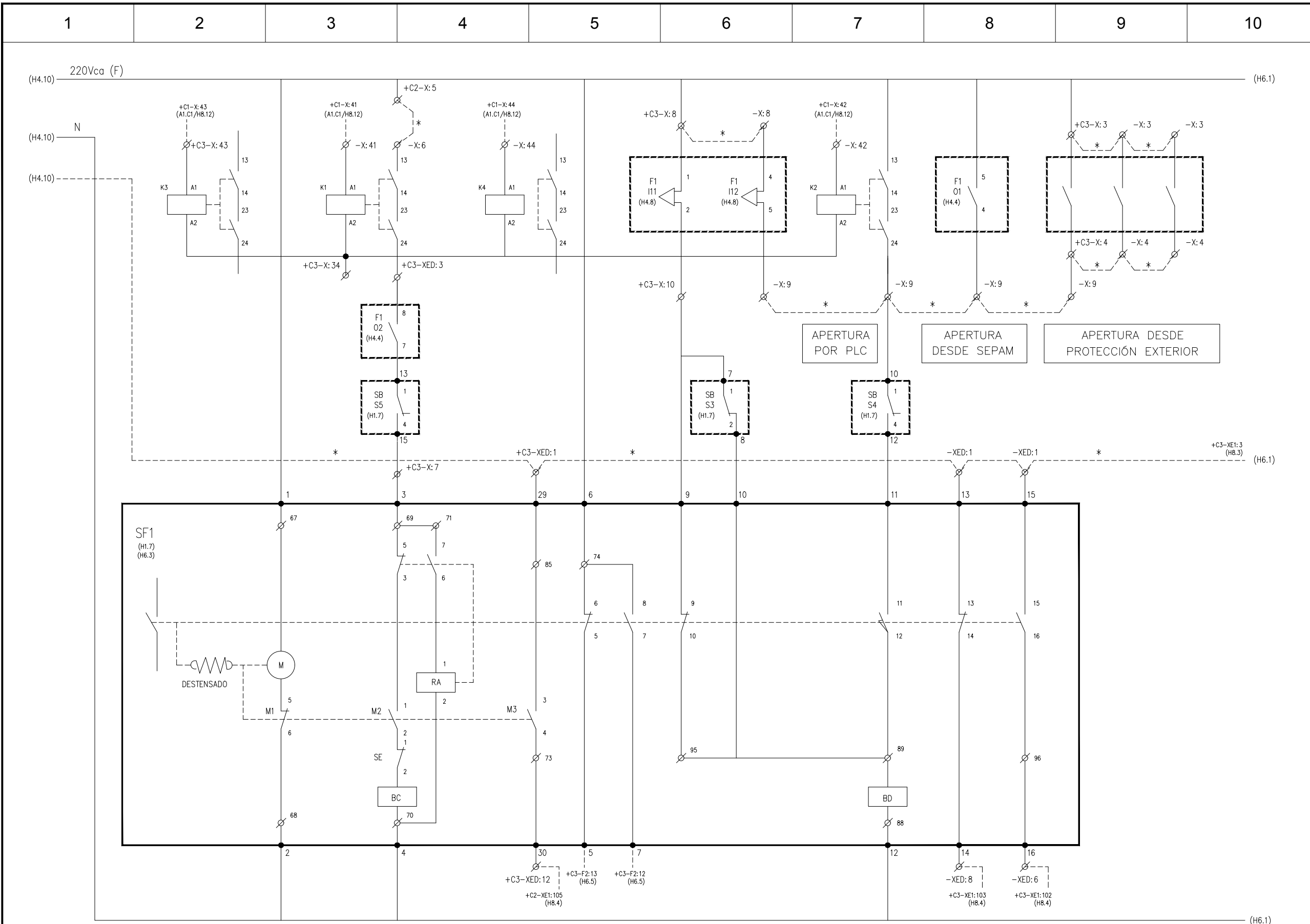

OHARRAK :
NOTAS :

REV.	CLASE DE MODIFICACION	FECHA	NOMBRE	COMP.	OBRA
A	PRIMERA EMISION	MAR. 23	IAA	ETS	

AHOLKULARIA / CONSULTOR		INGENIARI EGILEA INGENIERO AUTOR	
CAF		TURNKEY ENGINEERING	
AHOLKULARIAREN ERREFERENTZIA REFERENCIA CONSULTOR		ERREFERENTZIA REFERENCIA	
TTE-IS-23001-DRW-0129		2RVA-IE-22-129-A	

MOTOR	CIERRE Y ENCLAVAMIENTO	MUELLES TENSADOS	ESTADO DISYUNTOR	VIGILANCIA CIRCUITO DISPARO	APERTURA	DISYUNTOR
						ABIERTO CERRADO

+A1.C3 DETALLE DISYUNTOR SF1

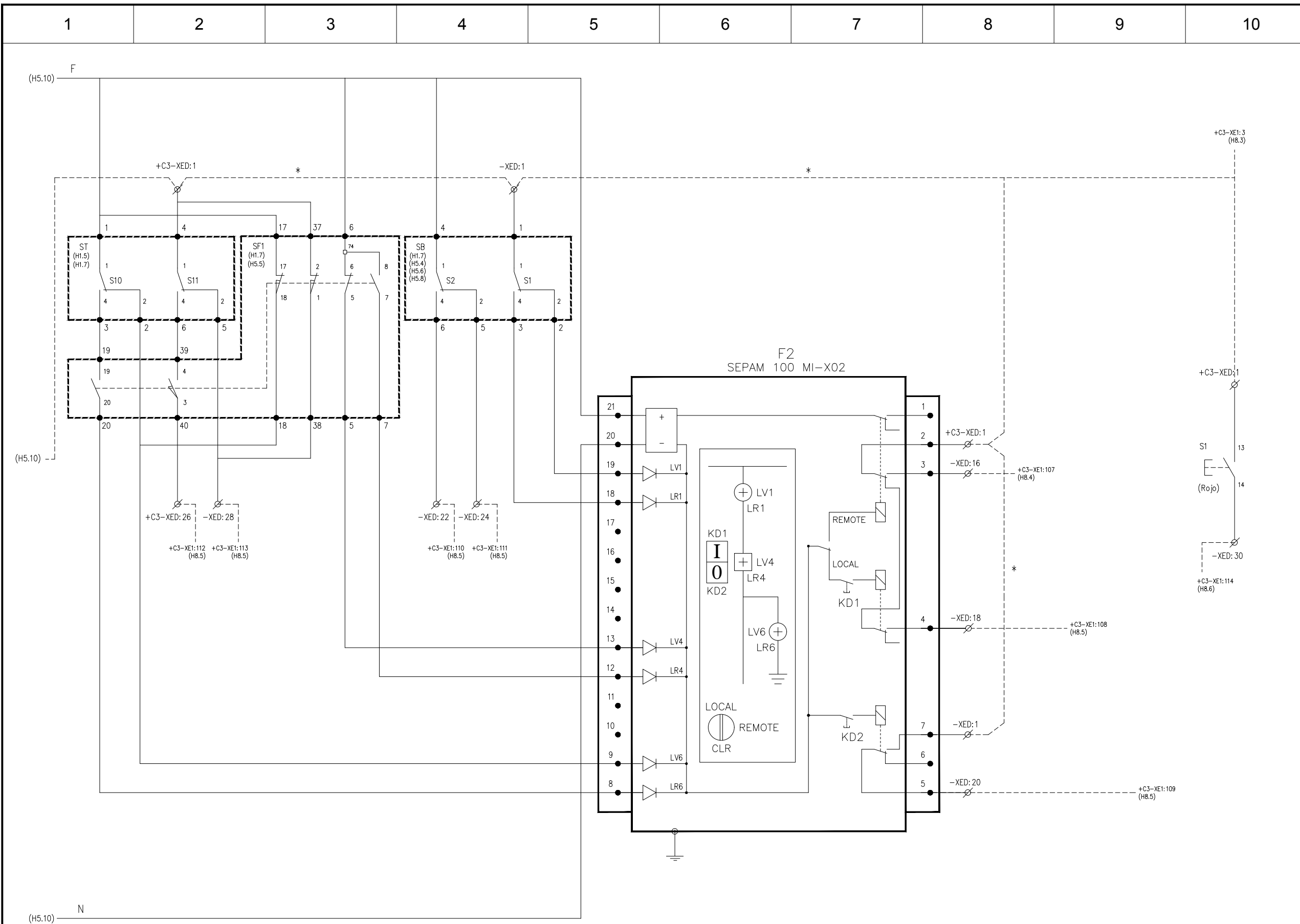

OHARRAK :
NOTAS :

ESTADO SECCIONADOR A TIERRA	ESTADO DISYUNTOR	ESTADO SECCIONADOR DE BARRAS	SELECTOR MANUAL LOCAL / REMOTO	SEÑALIZACIÓN CELDA EN REMOTO	ORDEN DE CIERRE	ORDEN DE APERTURA	DESBLOQUEO PLC
-----------------------------	------------------	------------------------------	--------------------------------	------------------------------	-----------------	-------------------	----------------

+A1.C3 ESTADO DISYUNTOR, SECCIONADORES Y RELÉ DE SÍMBOLO Y MANDO TIPO SEPAM 100-MI-X02 (CONTROL DE MANDO)

REV.	CLASE DE MODIFICACION	FECHA	NOMBRE	COMP.	OBRA
A	PRIMERA EMISION	MAR. 23	IAA	ETS	
BERRIKUSPENAK / REVISIONES					
AHOLKULARIA / CONSULTOR			INGENIARI EGILEA INGENIERO AUTOR		
CAF			TURNKEY ENGINEERING		
AHOLKULARIAREN ERREFERENTZIA REFERENCIA CONSULTOR			ERREFERENTZIA REFERENCIA		
TTE-IS-23001-DRW-0130			2RVA-IE-22-130-A		

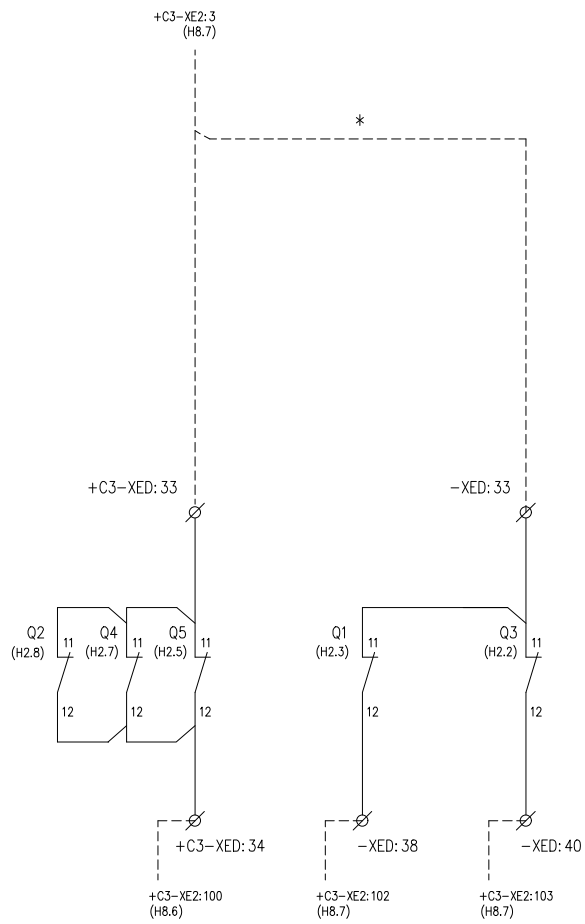

INTERRUPTOR MAGNETOTÉRMICO ABIERTO	PROTECCIÓN ALIMENTACIÓN PLC ABIERTA	PROTECCIÓN ALIMENTACIÓN CTRL. ABIERTA	
--	---	---	--

+A1.C3 CONTACTOS AUXILIARES

REV.	CLASE DE MODIFICACION	FECHA	NOMBRE	COMP.	OBRA
A	PRIMERA EMISIÓN	MAR. 23	IAA	ETS	
BERRIKUSPENAK / REVISIONES					
AHOLKULARIA / CONSULTOR			INGENIARI EGILEA INGENIERO AUTOR		
CAF TURNKEY ENGINEERING					
AHOLKULARIAREN ERREFERENTZIA REFERENCIA CONSULTOR			ERREFERENTZIA REFERENCIA		
TTE-IS-23001-DRW-0131			2RVA-IE-22-131-A		

ALIMENTACIÓN PLC
Y TARJETAS
(H2.3)

+24Vcc 0Vcc

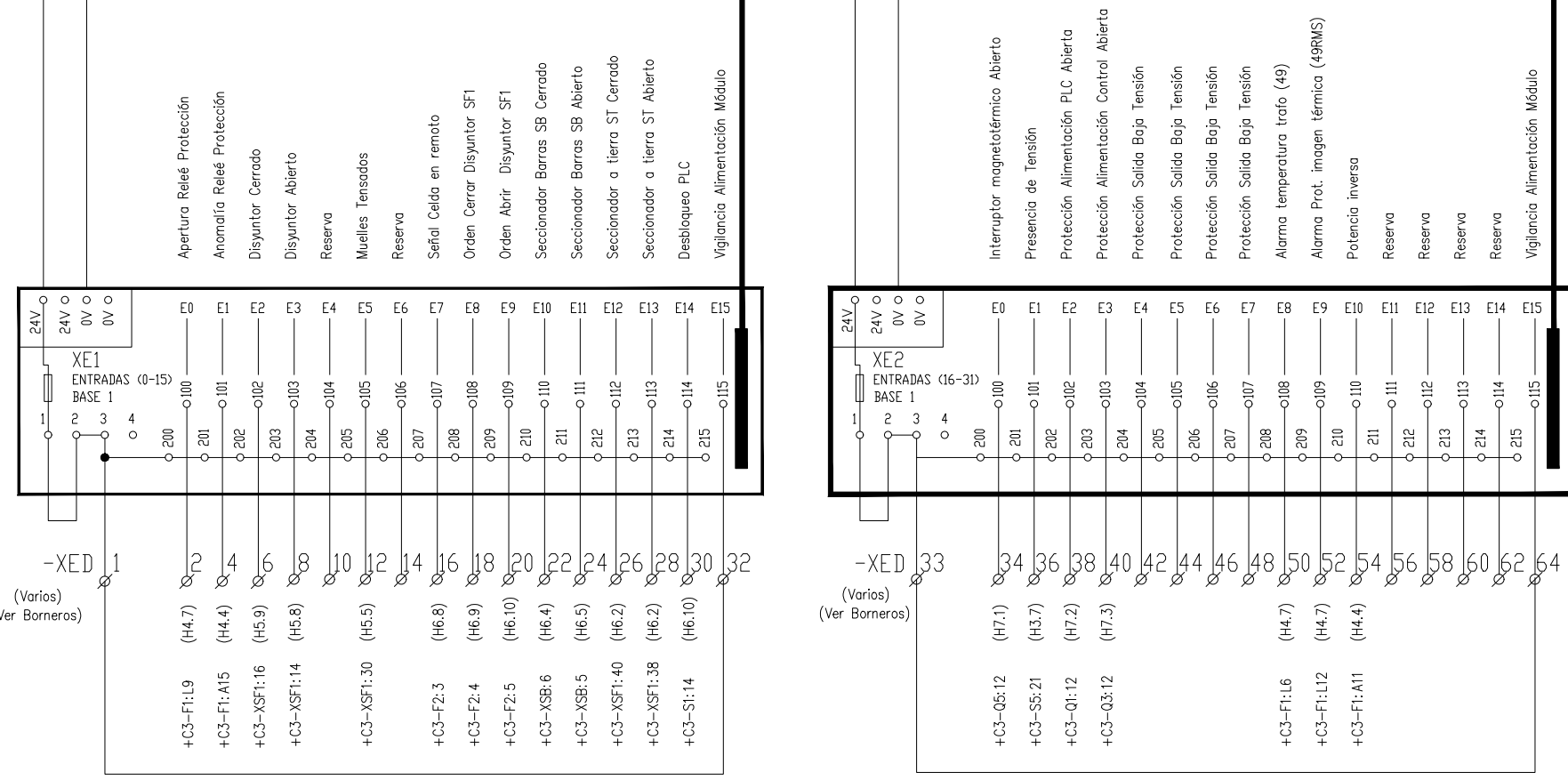
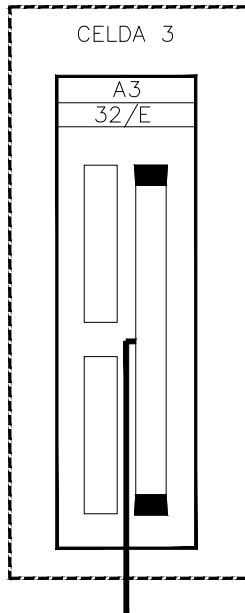
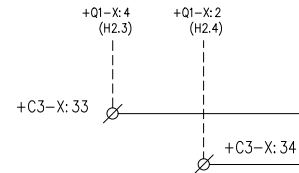

SWITCH DE COMUNICACIÓN

REGLETERO TARJETAS DE ENTRADA A PLC

+A1.C3 ESQUEMA CONJUNTO PLC

REV.	PRIMERA EMISIÓN	MAR. 23	IAA	ETS
	CLASE DE MODIFICACION	FECHA	NOMBRE	COMP. OBRA
BERRIKUSPENAK / REVISIONES				
AHOLKULARIA / CONSULTOR		INGENIARI EGILEA INGENIERO AUTOR		
AHOLKULARIAREN ERREFERENTZIA REFERENCIA CONSULTOR		ERREFERENTZIA REFERENCIA		
TTE-IS-23001-DRW-0132		2RVA-IE-22-132-A		

1 2 3 4 5 6 7 8 9 10

OHARRAK :
NOTAS :

BORNAS DISYUN. SF1
M4/6

1	2	3	4	5	6	7	9	10	11	12	13	14	15	16	17	18	18	19	20	21	22	23	24	25	26	27	28	29	30	31	32	33	34	35	36	37	38	38	39	40	
1	2	3	4	5	6	7	9	10	11	12	13	14	15	16	17	18	18	19	20	21	22	23	24	25	26	27	28	29	30	31	32	33	34	35	36	37	38	38	39	40	
	-X:1	-X:2	-X:7	-X:2	F2:13	-X:1	F2:12	-X:10	-XSB:8	-XSB:12	-X:2	-XED:1	-XED:8	-XED:1	-XED:6	-XST:1	F2:9	-XST:2	-XST:3										-XED:1	-XED:12							-XST:4	-XED:28	-XST:5	-XST:6	-XED:26

BORNAS SECC. ST
M4/6.D2

1	1	2	3	4	4	5	6	7	8	9
S10:1		S10:2	S10:4	S11:1	S11:1	S11:2	S11:4	S12:1	S12:2	S12:4
-X:1	-XSF1:17	-XSF1:18	-XSF1:19	-XED:1	-XSF1:37	-XSF1:38	-XSF1:39			

BORNAS SECC. SB
M4/6.D2

1	2	3	4	5	6	7	8	9	10	11	12	13	14	15	16	17	18	19	20	21	22	23	24	25	26	27
S1:1	S1:2	S1:4	S2:1	S2:2	S2:4	S3:1	S3:2	S3:4	S4:1	S4:2	S4:4	S5:1	S5:2	S5:4	S6:1	S6:2	S6:4	S7:1	S7:2	S7:4	S8:1	S8:2	S8:4	S9:1	S9:2	S9:4
-X:1	F2:19	F2:18	-XED:1	-XED:24	-XED:22	-X:10	-XSF1:10		-X:9		-XSF1:11	F1:A7	-X:7													

+A1.C3 BORNEROS DISYUNTOR (SF1) Y SECCIONADOR DE BARRAS (SB) Y A TIERRA (ST)

REV.	A	PRIMERA EMISION	MAR.23	IAA	ETS
BERRIKUSPENAK / REVISIONES					
AHOLKULARIA / CONSULTOR	INGENIARI EGILEA INGENIERO AUTOR				
TTE-IS-23001-DRW-0133		2RVA-IE-22-133-A			

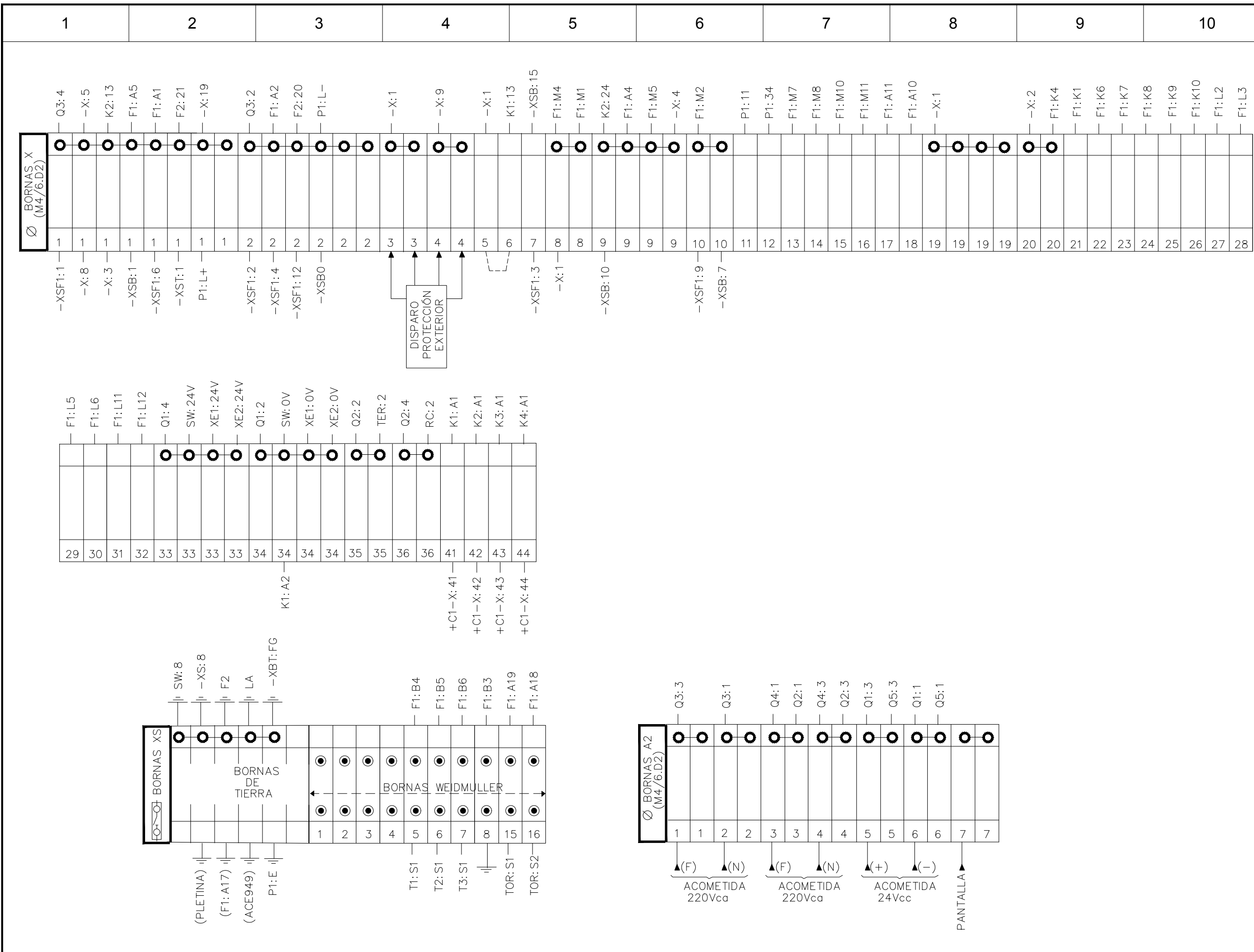

OHARRAK :
NOTAS :

+A1.C3 BORNEROS GENERAL, SECCIONABLES (XS) Y DE ACOMETIDA DE FUERZA (A2)

A	PRIMERA EMISION	MAR.23	IAA	ETS
REV.	CLASE DE MODIFICACION	FECHA	NOMBRE	COMP. OBRA
BERRIKUSPENAK / REVISIONES				
AHOLKULARIA / CONSULTOR		INGENIARI EGILEA INGENIERO AUTOR		
CAF		TURNKEY ENGINEERING		
AHOLKULARIAREN ERREFERENTZIA REFERENCIA CONSULTOR		ERREFERENTZIA REFERENCIA		
TTE-IS-23001-DRW-0134		2RVA-IE-22-134-A		

1 2 3 4 5 6 7 8 9 10

OHARRAK :
NOTAS :

Ø BORNAS XED (M4/6.D2)			
1	-XSF1:15	1	XE1:3
1	-XSF1:13	1	F1:L8
1	-XSF1:29	1	F1:A13
1	-XST:4	1	F2:2
1	-XSB:4	1	F2:11
1	S1:13	1	-XED:32
2	F1:L9	2	XE1:100
3	K1:24	3	F1:A8
4	F1:A15	4	XE1:101
6	-XSF1:16	6	XE1:102
8	-XSF1:14	8	XE1:103
10		10	XE1:104
12	-XSF1:30	12	XE1:105
14		14	XE1:106
16	F2:3	16	XE1:107
18	F2:4	18	XE1:108
20	F2:5	20	XE1:109
22	-XSB:6	22	XE1:110
24	-XSB:5	24	XE1:111
26	-XSF1:40	26	XE1:112
28	-XSF1:38	28	XE1:113
30	S1:14	30	XE1:114
32	-XED:1	32	XE1:115
33	P1:41	33	XE2:3
33	-XED:64	33	Q5:11
33		33	Q3:11
33		33	
34	Q5:12	34	XE2:100
36	S5:21	36	XE2:101
38	Q1:12	38	XE2:102
40	Q3:12	40	XE2:103
42		42	XE2:104
44		44	XE2:105
46		46	XE2:106
48		48	XE2:107
50	F1:L6	50	XE2:108
52	F1:L12	52	XE2:109
54		54	XE2:110
56		56	XE2:111
58		58	XE2:112
60		60	XE2:113
62		62	XE2:114
64	-XED:33	64	XE2:115

REV.	CLASE DE MODIFICACION	FECHA	NOMBRE	COMP.	OBRA
A	PRIMERA EMISION	MAR. 23	IAA	ETS	

BERRIKUSPENAK / REVISIONES

AHOLKULARIA / CONSULTOR	INGENIARI EGILEA INGENIERO AUTOR
CAF TURNKEY ENGINEERING	
	IKER AIZPURU ARAGON - Nº COL. 1999

AHOLKULARIAREN ERREFERENTZIA REFERENCIA CONSULTOR	ERREFERENTZIA REFERENCIA
TTE-IS-23001-DRW-0135	2RVA-IE-22-135-A

+A1.C3 BORNERO PARA TARJETAS DE ENTRADA A PLC (XED)

1 2 3 4 5 6 7 8 9 10

OHARRAK :
NOTAS :

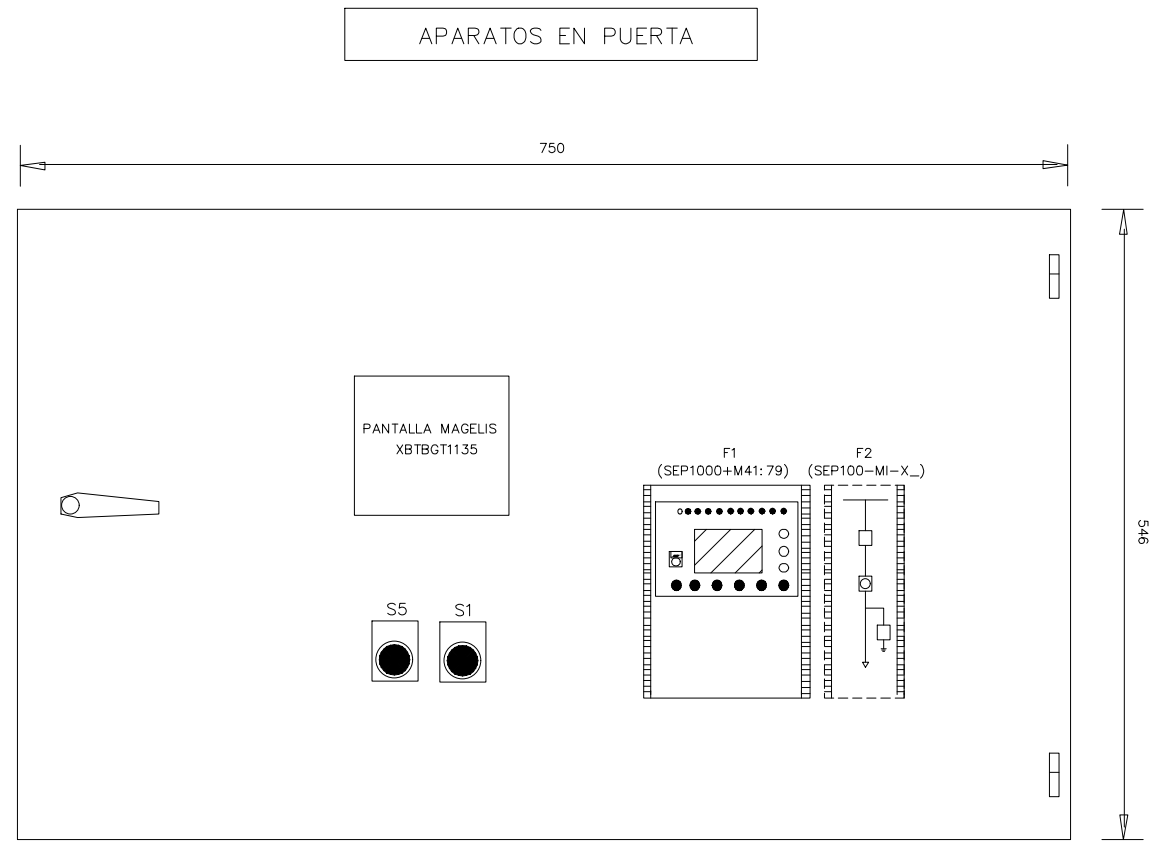

APARATOS EN CAJÓN B.T.

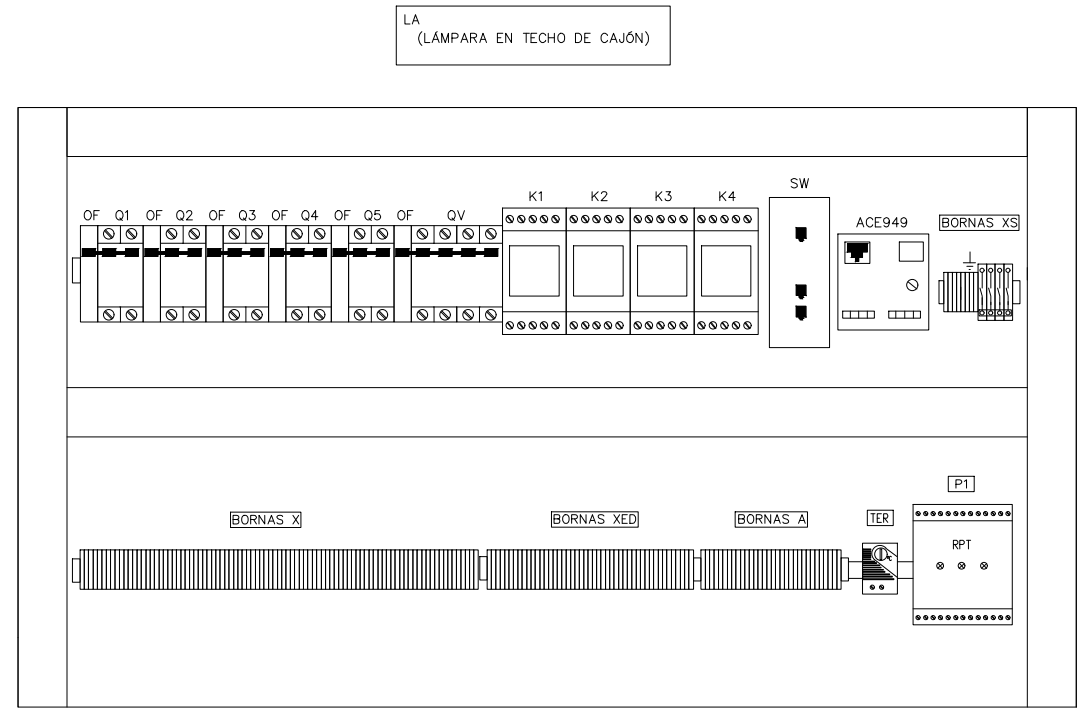

LATERAL IZQUIERDO CAJÓN

LATERAL DERECHO CAJÓN

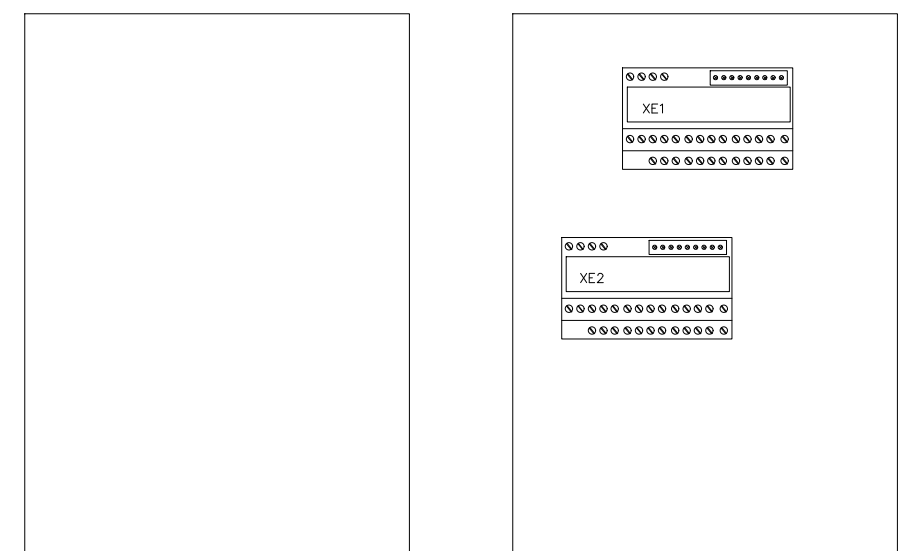

APARATOS EN COMPARTIMENTO B.T.

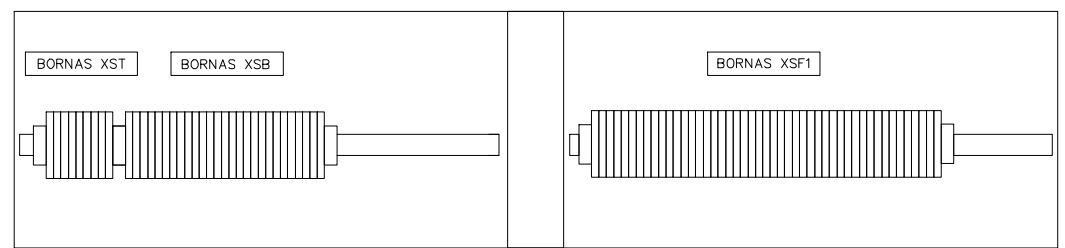

+A1.C3 DISPOSICIÓN FÍSICA DE LOS ELEMENTOS EN CAJÓN DE CELDA

REV.	CLASE DE MODIFICACION	FECHA	NOMBRE	COMP.	OBRA
A	PRIMERA EMISION	MAR. 23	IAA	ETS	

BERRIKUSPENAK / REVISIONES

AHOLKULARIA / CONSULTOR	INGENIARI EGILEA INGENIERO AUTOR
CAF TURNKEY ENGINEERING	
	IKER AIZPURU ARAGON - Nº COL. 1999

AHOLKULARIAREN ERREFERENTZIA REFERENCIA CONSULTOR	ERREFERENTZIA REFERENCIA
--	-----------------------------

TTE-IS-23001-DRW-0136 2RVA-IE-22-136-A