

OHARRAK:
NOTAS:

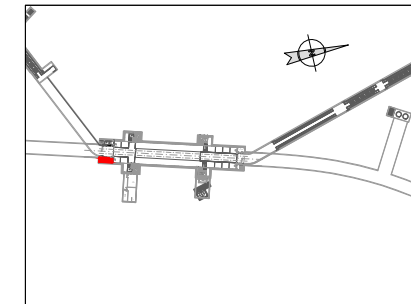

LEYENDA

- 1 RACK AUXILIAR DE COMUNICACIONES
- 2 RACK SEGURIDAD
- 3 RACK INFORMACIÓN AL VIAJERO
- PF PUESTO FIJO TREN-TIERRA
- T2 REPARTIDOR CUADRETES

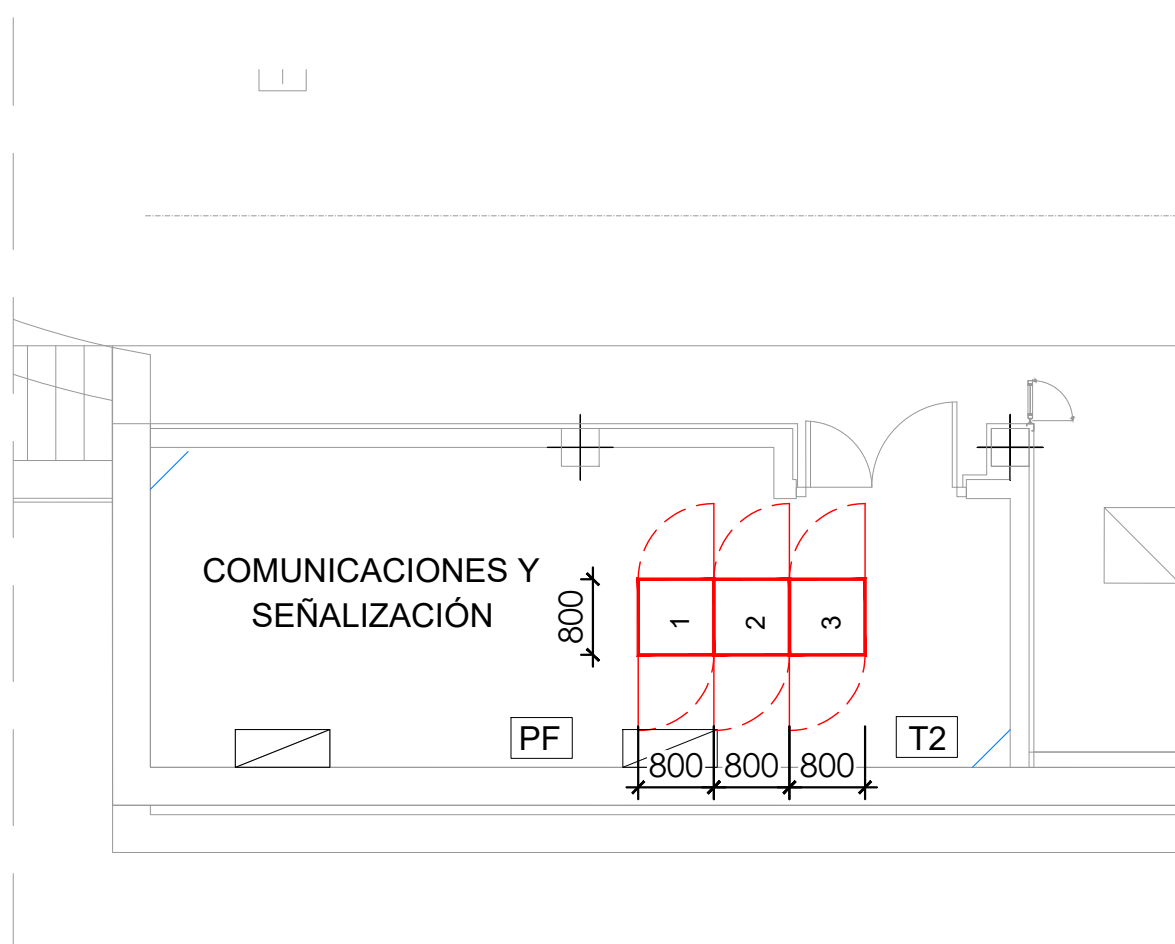

REV.	CLASE DE MODIFICACION	FECHA	NOMBRE	COMP.	OBRA
A	PRIMERA EMISION	OCT. 23	A.B.V.	J.I.A.	

BERRIKUSPENAK / REVISIONES

AHOLKULARIA / CONSULTOR SYSTRA	INGENIARI EGILEA / INGENIERO AUTOR JUAN IRIZAR-APARICIO Ingeniero Industrial
------------------------------------------	------------------------------------------------------------------------------------

AHOLKULARIAREN ERREFERENTZIA / REFERENCIA CONSULTOR	ERREFERENTZIA / REFERENCIA
-----------------------------------------------------	----------------------------

MD-C-23-195-A

REF: MD-C-23-195-A.dwg

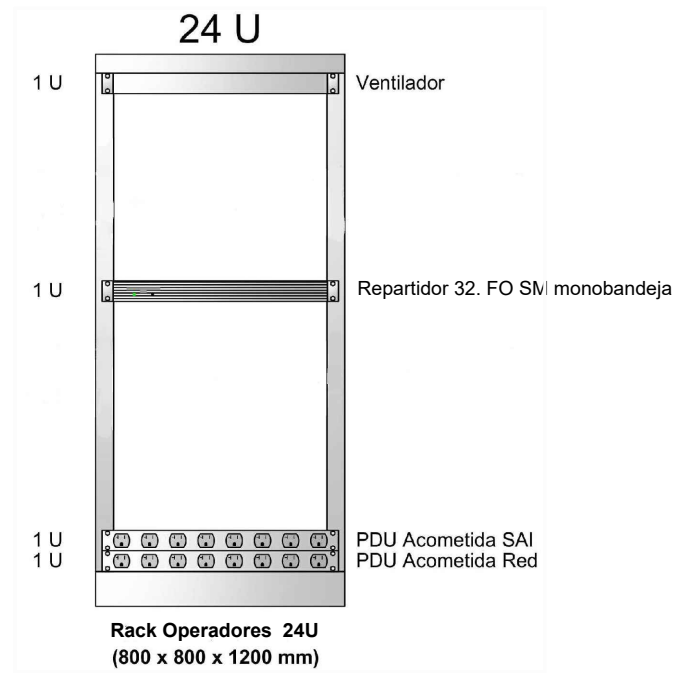
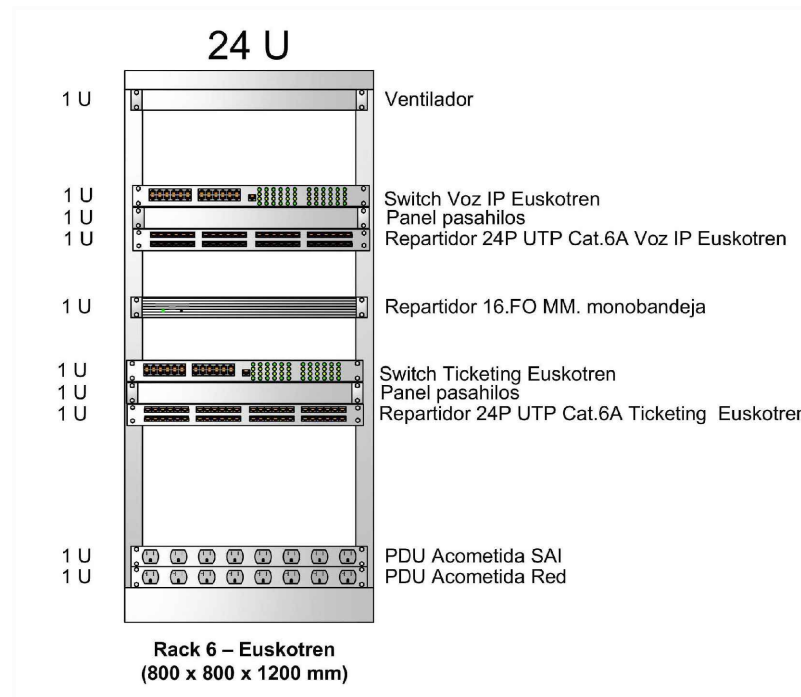

OHARRAK:
NOTAS:

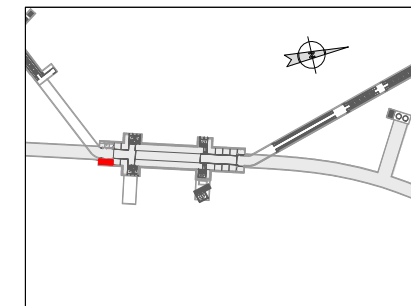

LEYENDA

- 4 RACK EUSKOTREN 24U
- 5 RACK OPERADORES 24U

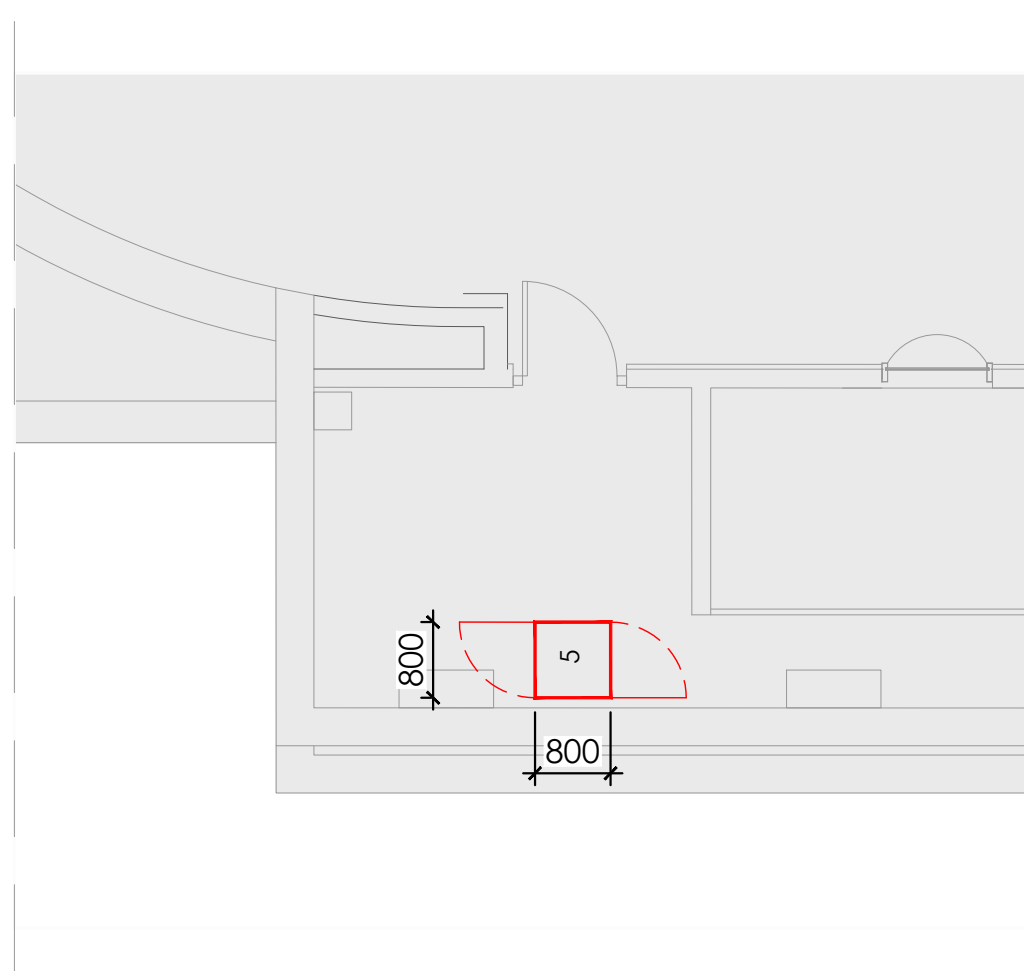
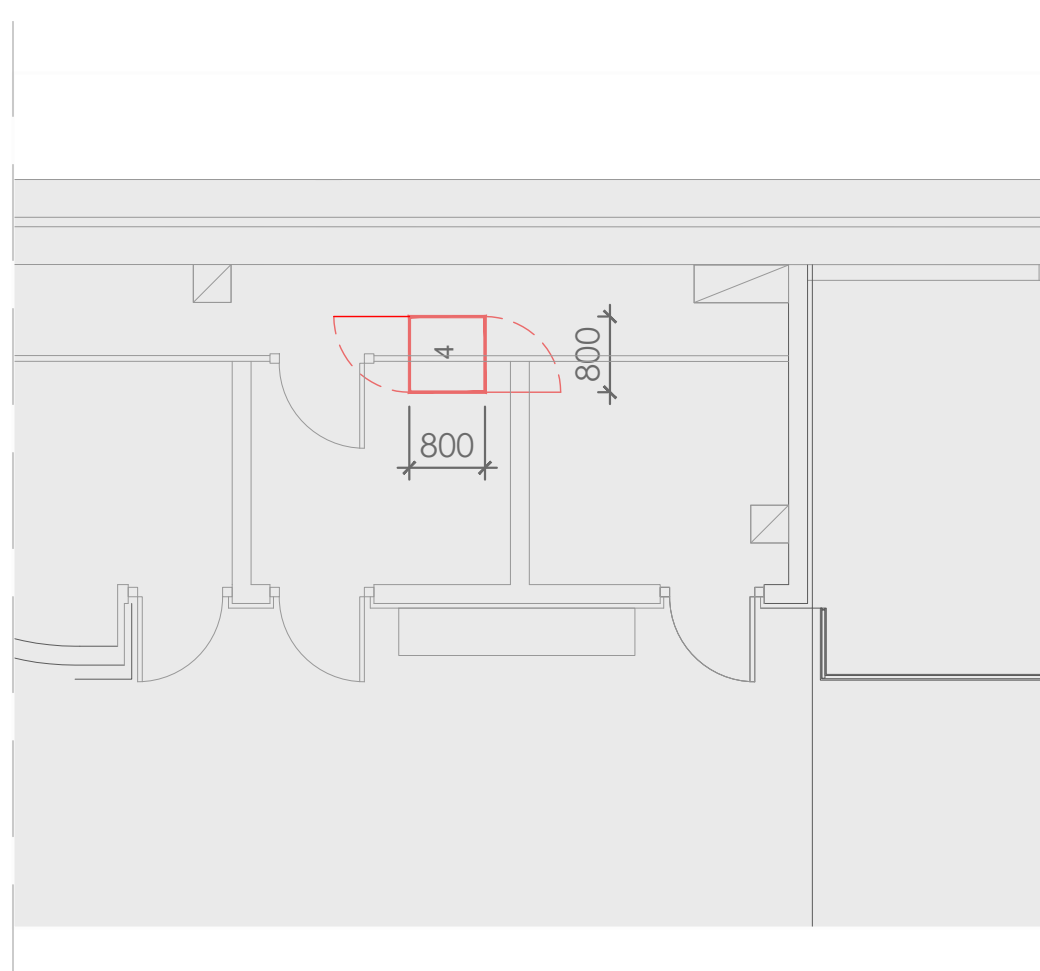

REV.	CLASE DE MODIFICACION	FECHA	NOMBRE	COMP.	OBRA
A	PRIMERA EMISION	OCT. 23	A.B.V.	J.I.A.	

BERRIKUSPENAK / REVISIONES

AHOLKULARIA / CONSULTOR	INGENIARI EGILEA INGENIERIA AUTORA
SYSTRA	JUAN IRIZAR APARICIO Ingeniero Industrial

AHOLKULARIAREN ERREFERENTZIA REFERENCIA CONSULTOR	ERREFERENTZIA REFERENCIA
------------------------------------------------------	-----------------------------

MD-C-23-196-A

REF: MD-C-23-196-A.dwg

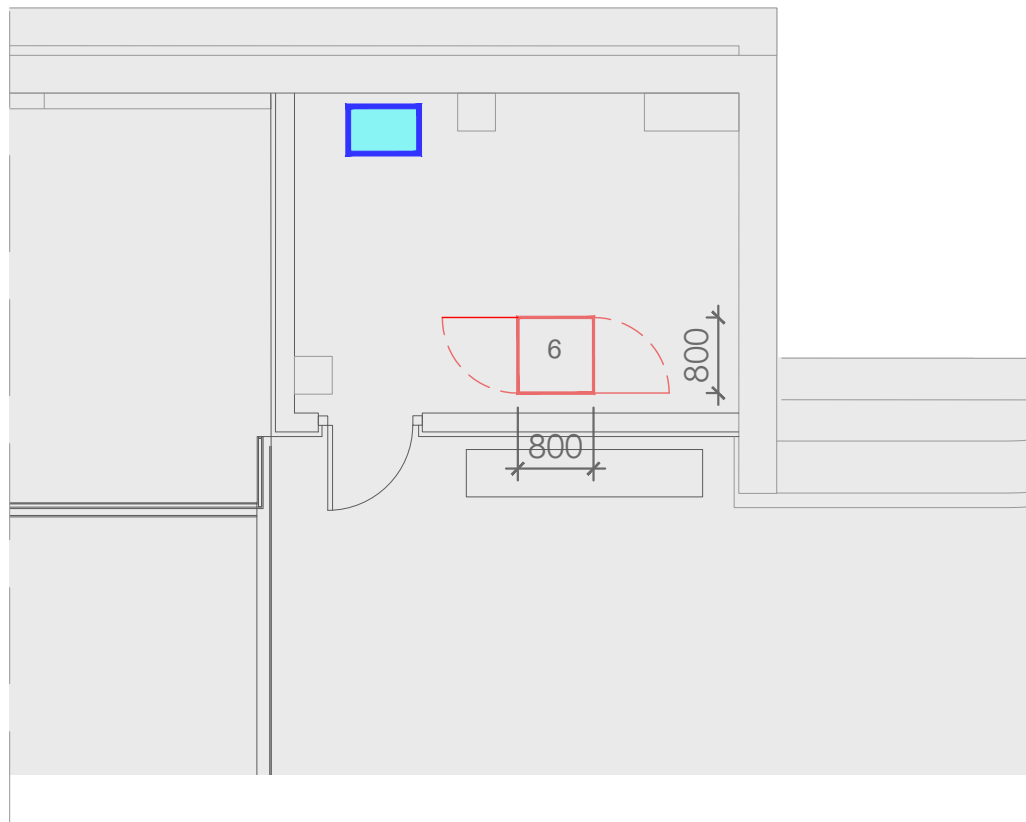
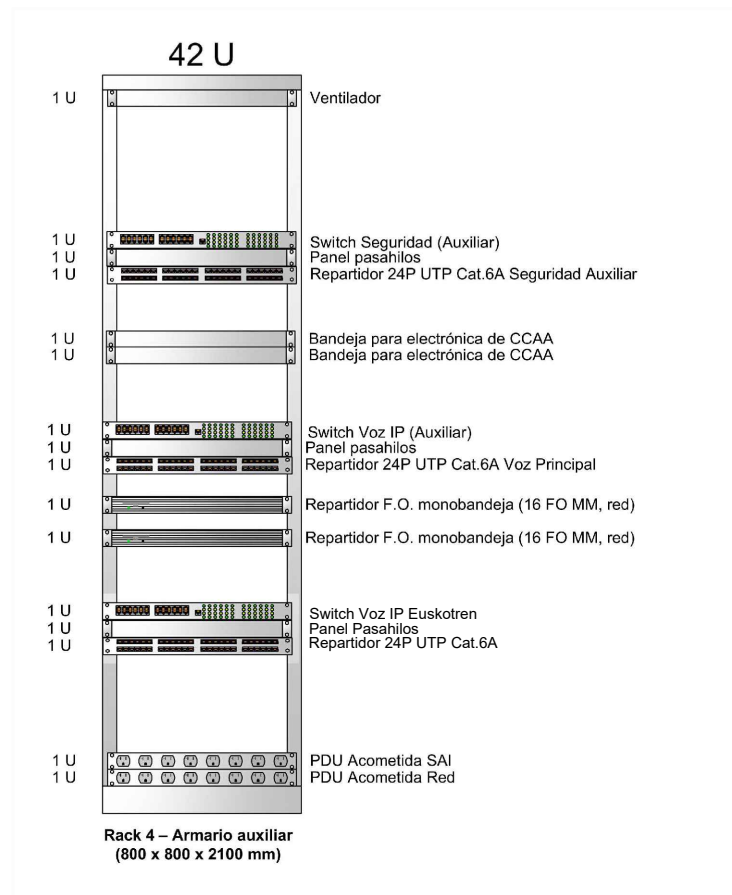

OHARRAK:
NOTAS:

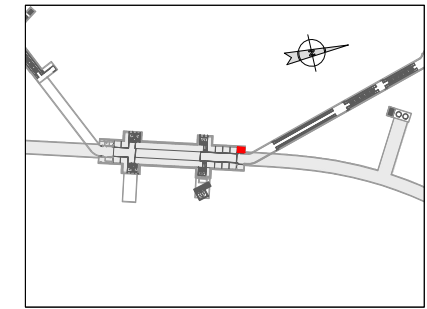

LEYENDA

- 6 RACK ARMARIO AUXILIAR 42U
- ARMARIO MURAL DISTRIBUCIÓN TETRA

REV.	CLASE DE MODIFICACION	FECHA	NOMBRE	COMP.	OBRA
A	PRIMERA EMISION	OCT. 23	A.B.V.	J.I.A.	

BERRIKUSPENAK / REVISIONES

AHOLKULARIA / CONSULTOR	INGENIARI EGILEA INGENIERO AUTOR
SYSTRA	<i>Juan Irizar</i> JUAN IRIZAR APARICIO Ingeniero Industrial

AHOLKULARIAREN ERREFERENTZIA REFERENCIA CONSULTOR	ERREFERENTZIA REFERENCIA
------------------------------------------------------	-----------------------------

MD-C-23-197-A

REF: MD-C-23-197-A.dwg

OHARRAK:
NOTAS:

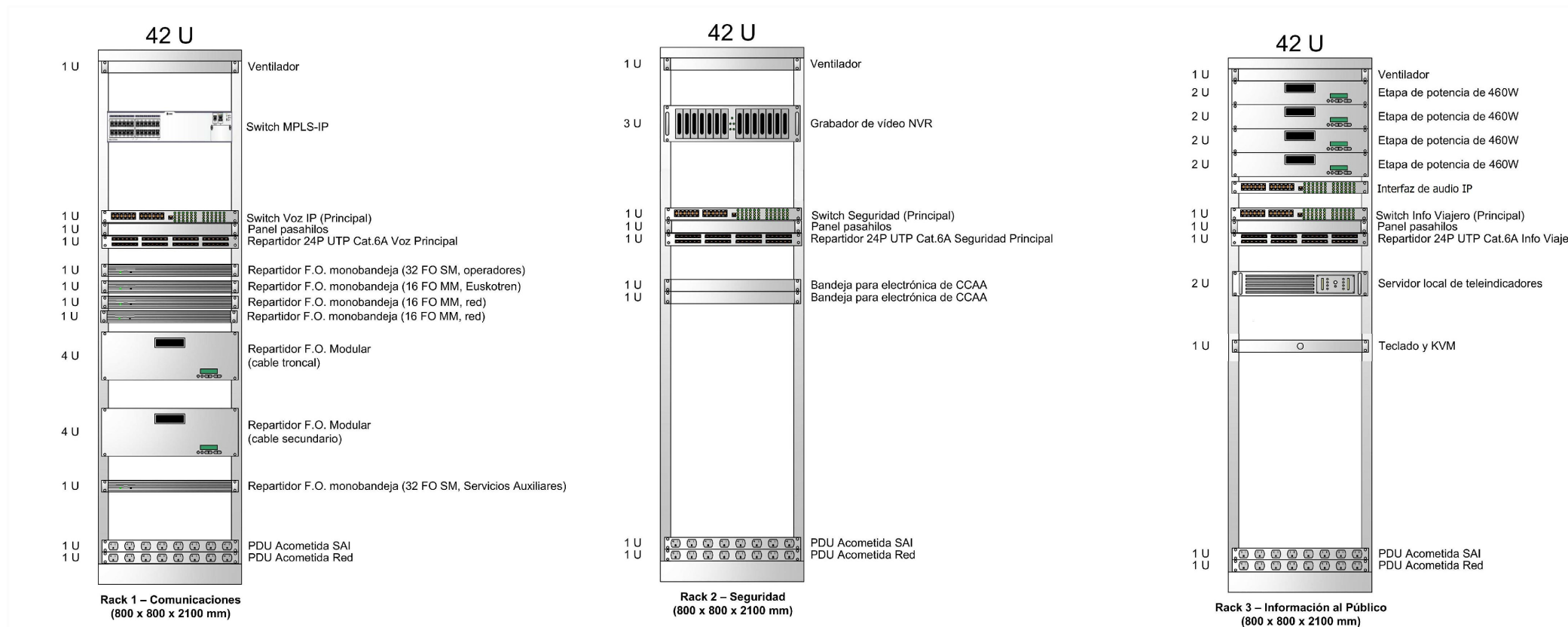
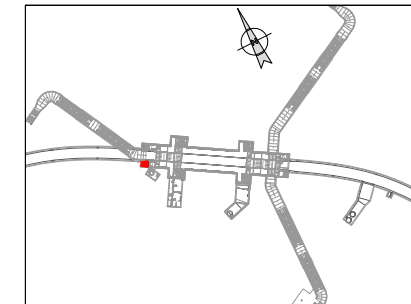

LEYENDA

- 1 RACK AUXILIAR DE COMUNICACIONES
- 2 RACK SEGURIDAD
- 3 RACK INFORMACIÓN AL VIAJERO
- PF PUESTO FIJO TREN-TIERRA
- T2 REPARTIDOR CUADRETES

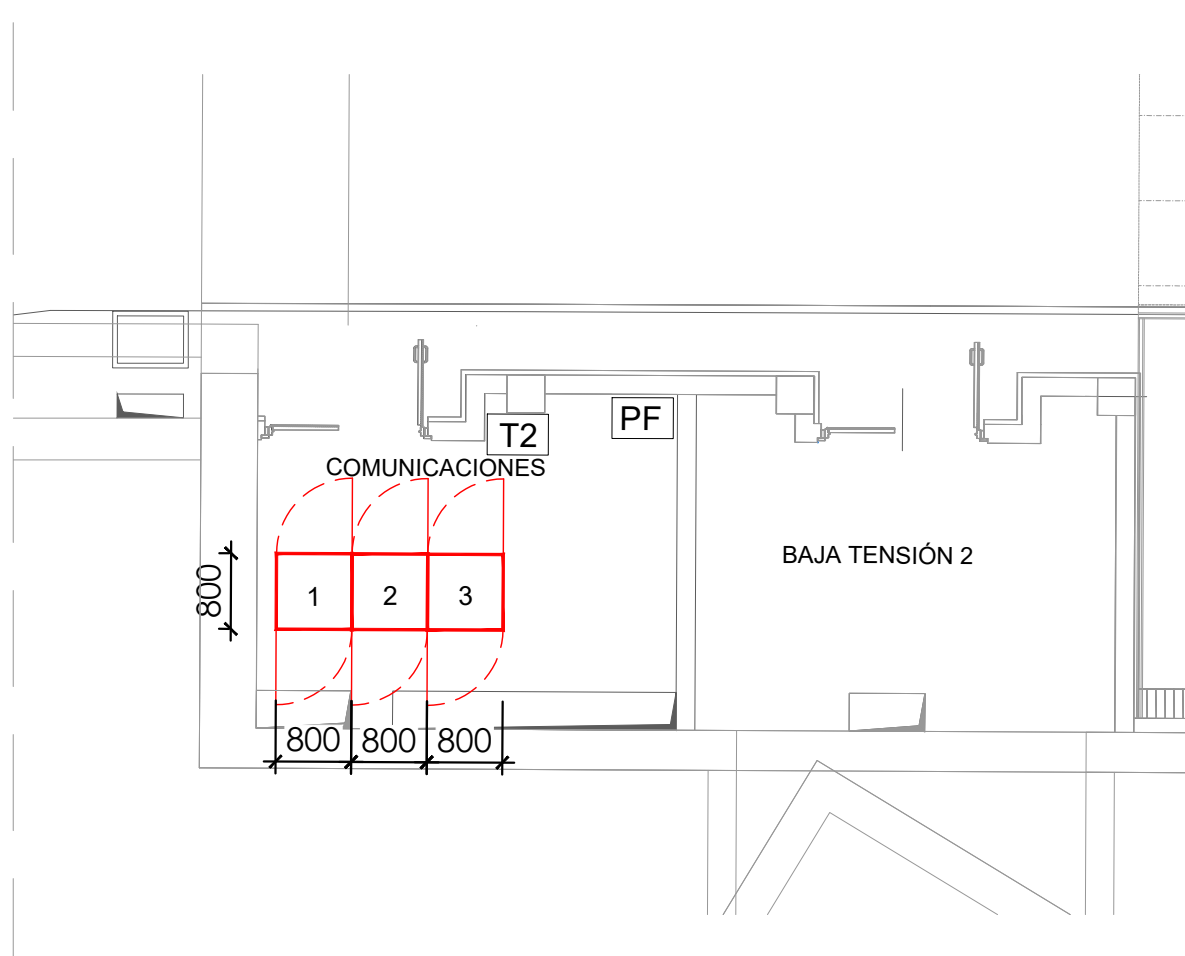

REV.	CLASE DE MODIFICACION	FECHA	NOMBRE	COMP.	OBRA
A	PRIMERA EMISION	OCT. 23	A.B.V.	J.I.A.	

BERRIKUSPENAK / REVISIONES

AHOLKULARIA / CONSULTOR	INGENIARI EGILEA / INGENIERO AUTOR
SYSTRA	JUAN IRIZAR APARICIO Ingeniero Industrial

AHOLKULARIAREN ERREFERENTZIA / REFERENCIA CONSULTOR	ERREFERENTZIA / REFERENCIA
-----------------------------------------------------	----------------------------

MD-C-23-198-A

REF: MD-C-23-198-A.dwg

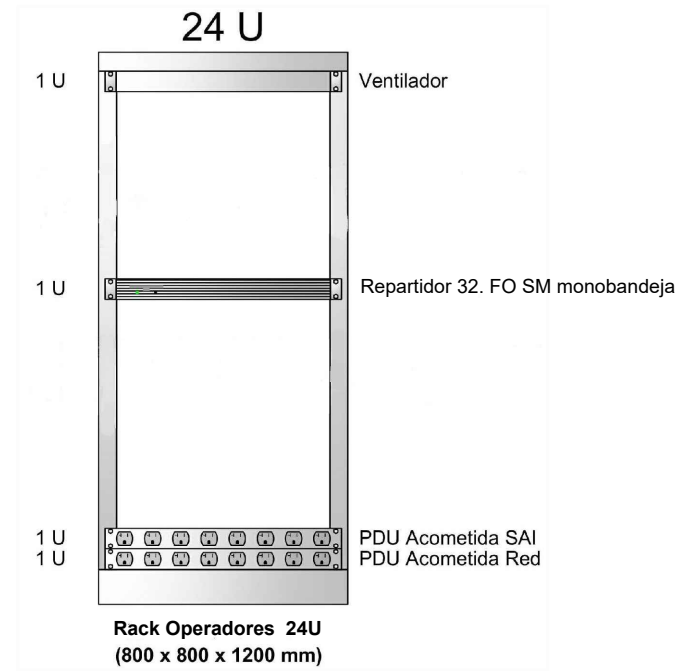
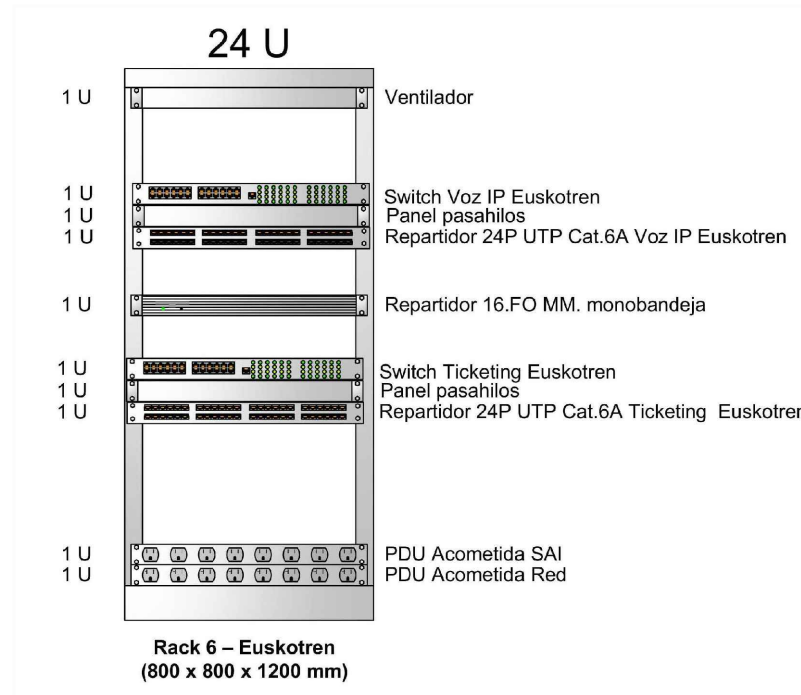

OHARRAK:
NOTAS:

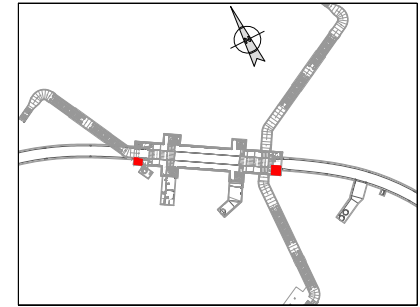

LEYENDA

- 4 RACK EUSKOTREN 24U
- 5 RACK OPERADORES 24U

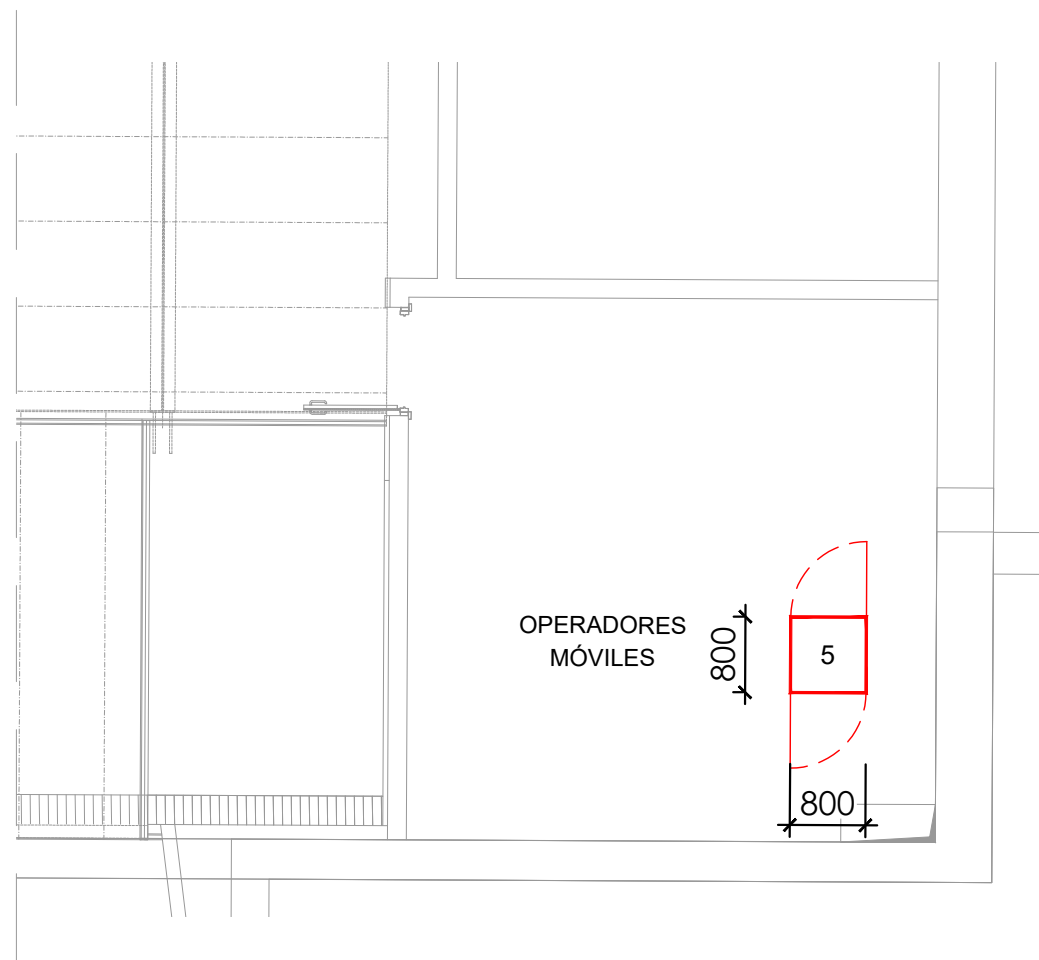
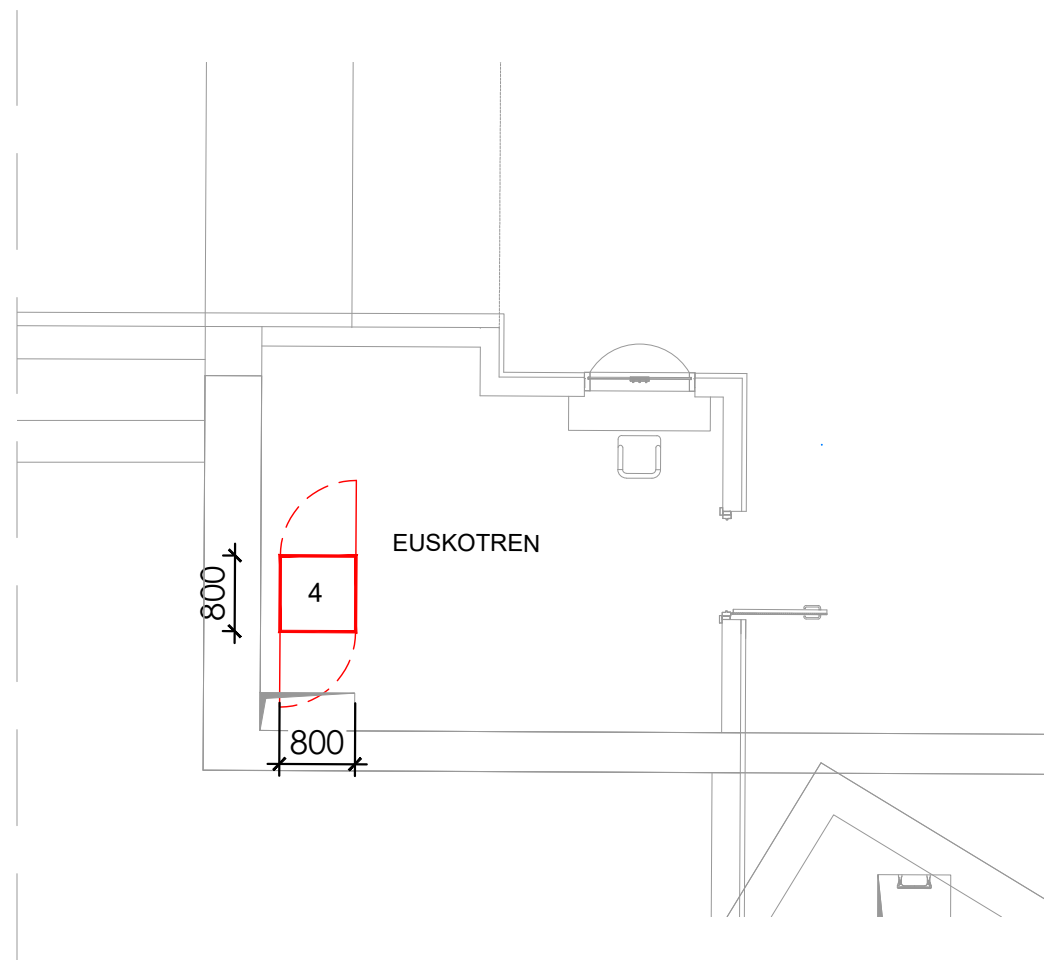

A	PRIMERA EMISION	OCT. 23	A.B.V.	J.I.A.
REV.	CLASE DE MODIFICACION	FECHA	NOMBRE	COMP. OBRA
BERRIKUSPENAK / REVISIONES				
AHOLKULARIA / CONSULTOR		INGENIARI EGILEA / INGENIERO AUTOR		
SYSTRA		JUAN IRIZAR APARTICIO Ingeniero Industrial		
AHOLKULARIAREN ERREFERENTZIA / REFERENCIA CONSULTOR		ERREFERENTZIA / REFERENCIA		
MD-C-23-199-A				

REF: MD-C-23-199-A.dwg

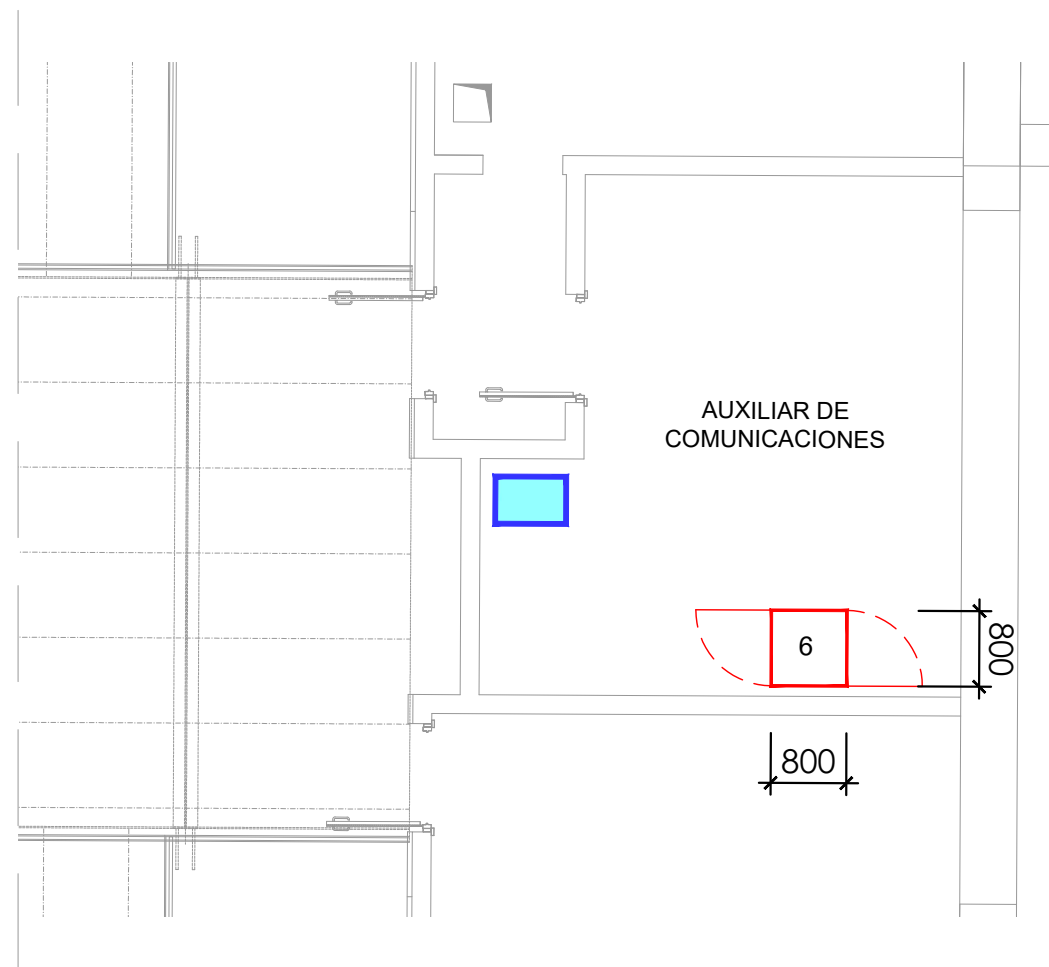
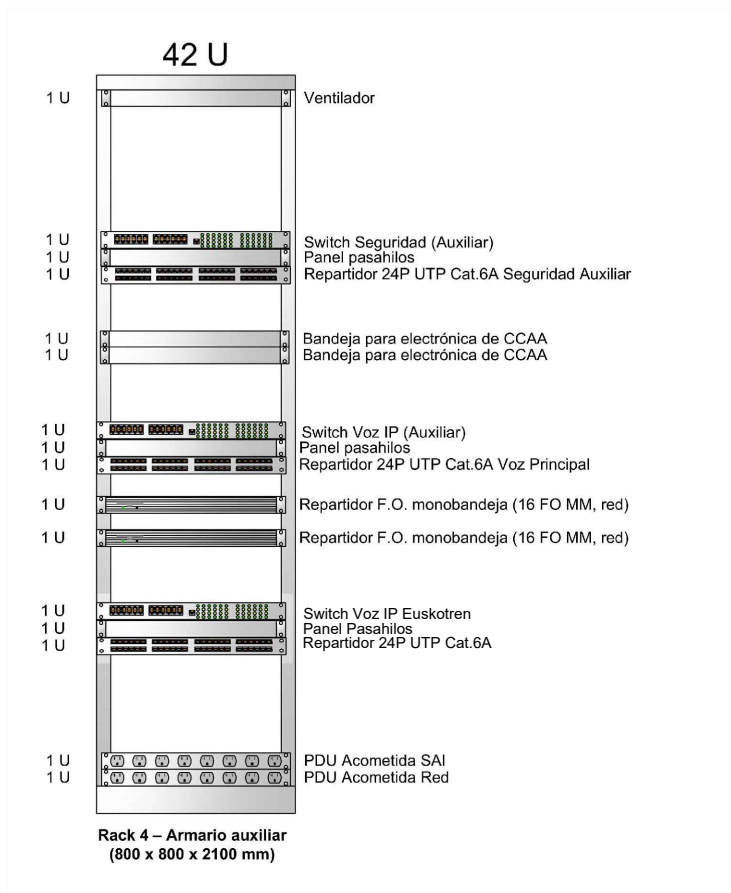

OHARRAK:
NOTAS:

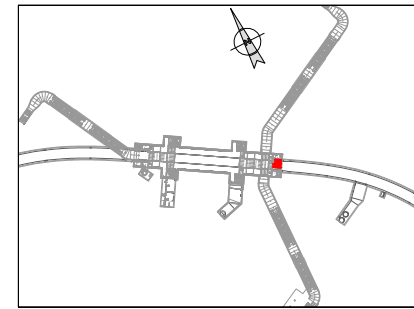

LEYENDA

- 6 RACK ARMARIO AUXILIAR 42U
- ARMARIO MURAL DISTRIBUCIÓN TETRA

A	PRIMERA EMISION	OCT. 23	A.B.V.	J.I.A.	
REV.	CLASE DE MODIFICACION	FECHA	NOMBRE	COMP.	OBRA
BERRIKUSPENAK / REVISIONES					
AHOLKULARIA / CONSULTOR 		INGENIARI EGILEA INGENIERIA AUTORA JUAN IRIZAR APARICIO Ingeniero Industrial			
AHOLKULARIAREN ERREFERENTZIA REFERENCIA CONSULTOR		ERREFERENTZIA REFERENCIA			
MD-C-23-200-A					

REF: MD-C-23-200-A.dwg

OHARRAK:
NOTAS:

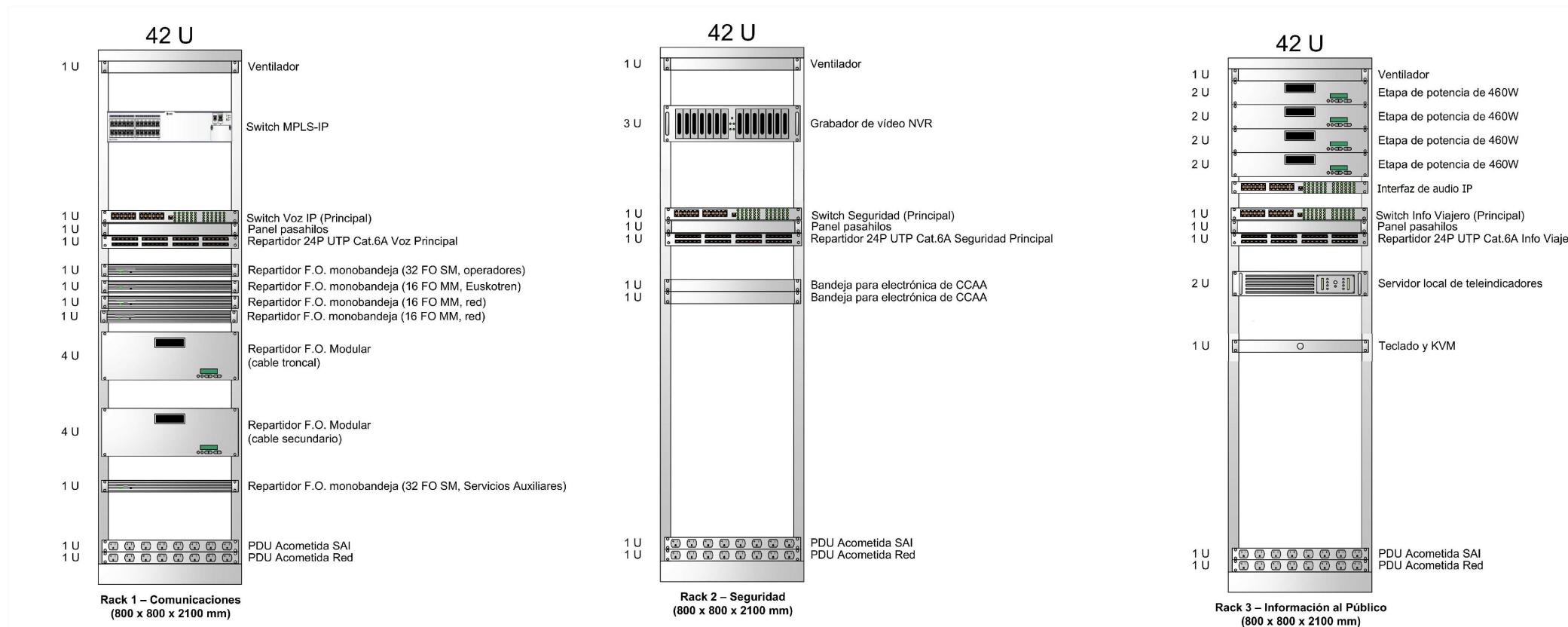
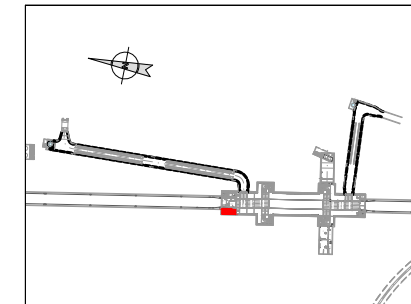

LEYENDA

- 1 RACK AUXILIAR DE COMUNICACIONES
- 2 RACK SEGURIDAD
- 3 RACK INFORMACIÓN AL VIAJERO
- PF PUESTO FIJO TREN-TIERRA
- T2 REPARTIDOR CUADRETES

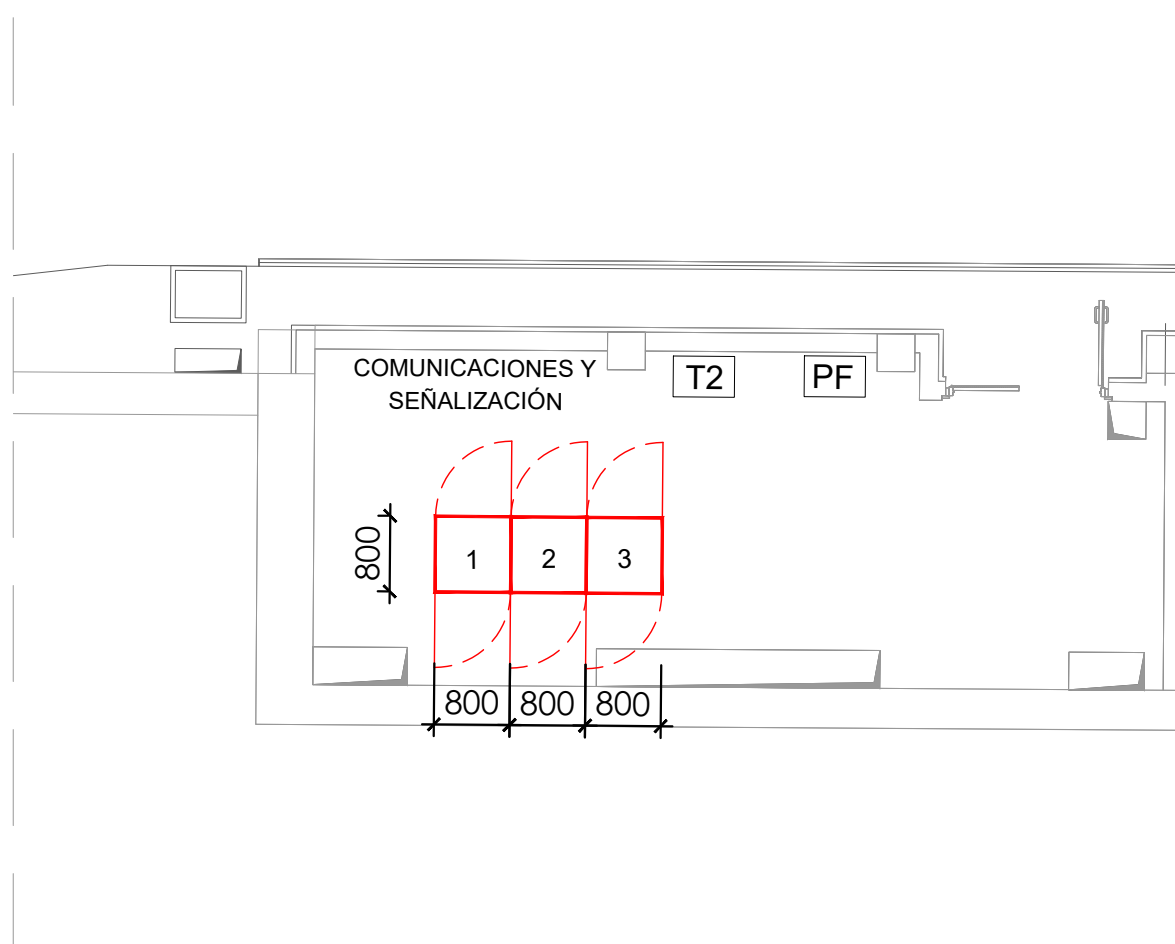

REV.	CLASE DE MODIFICACION	FECHA	NOMBRE	COMP.	OBRA
A	PRIMERA EMISION	OCT. 23	A.B.V.	J.I.A.	

BERRIKUSPENAK / REVISIONES

AHOLKULARIA / CONSULTOR	INGENIARI EGILEA / INGENIERO AUTOR
SYSTRA	JUAN IRIZAR APARICIO Ingeniero Industrial

AHOLKULARIAREN ERREFERENTZIA / REFERENCIA CONSULTOR	ERREFERENTZIA / REFERENCIA
-----------------------------------------------------	----------------------------

MD-C-23-201-A

REF: MD-C-23-201-A.dwg

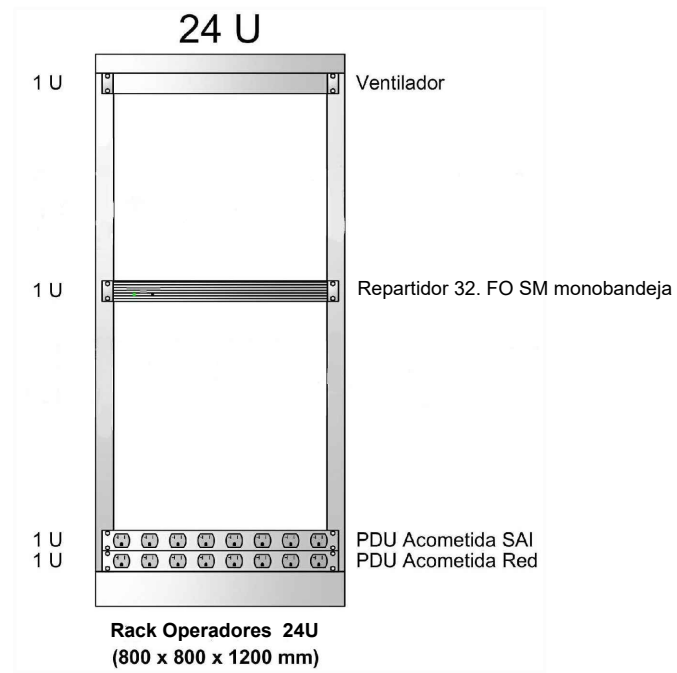
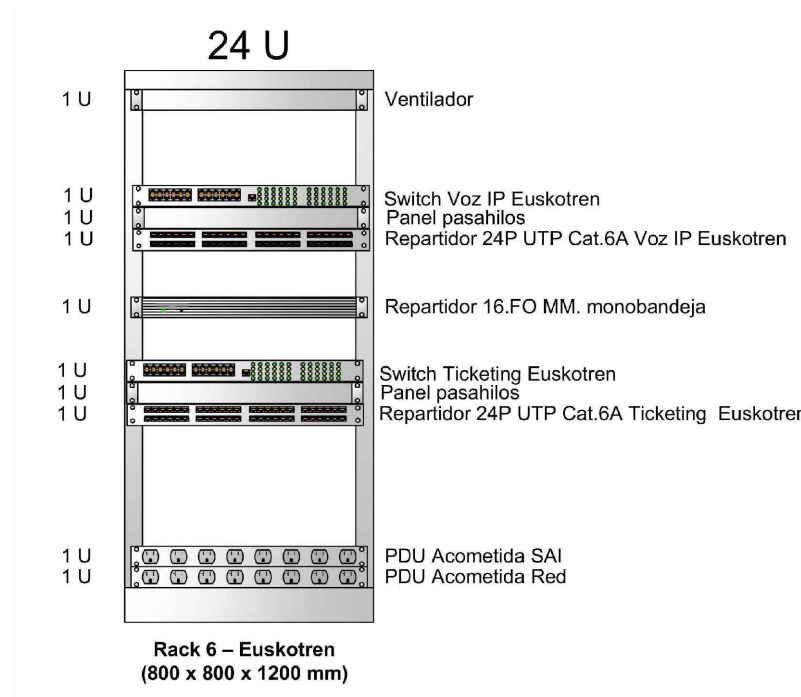

OHARRAK:
NOTAS:

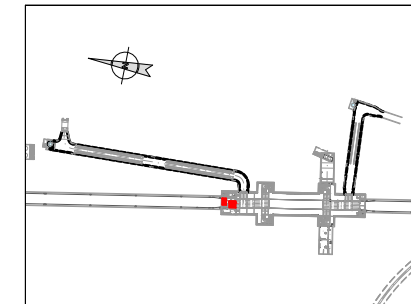

LEYENDA

- 4 RACK EUSKOTREN 24U
- 5 RACK OPERADORES 24U

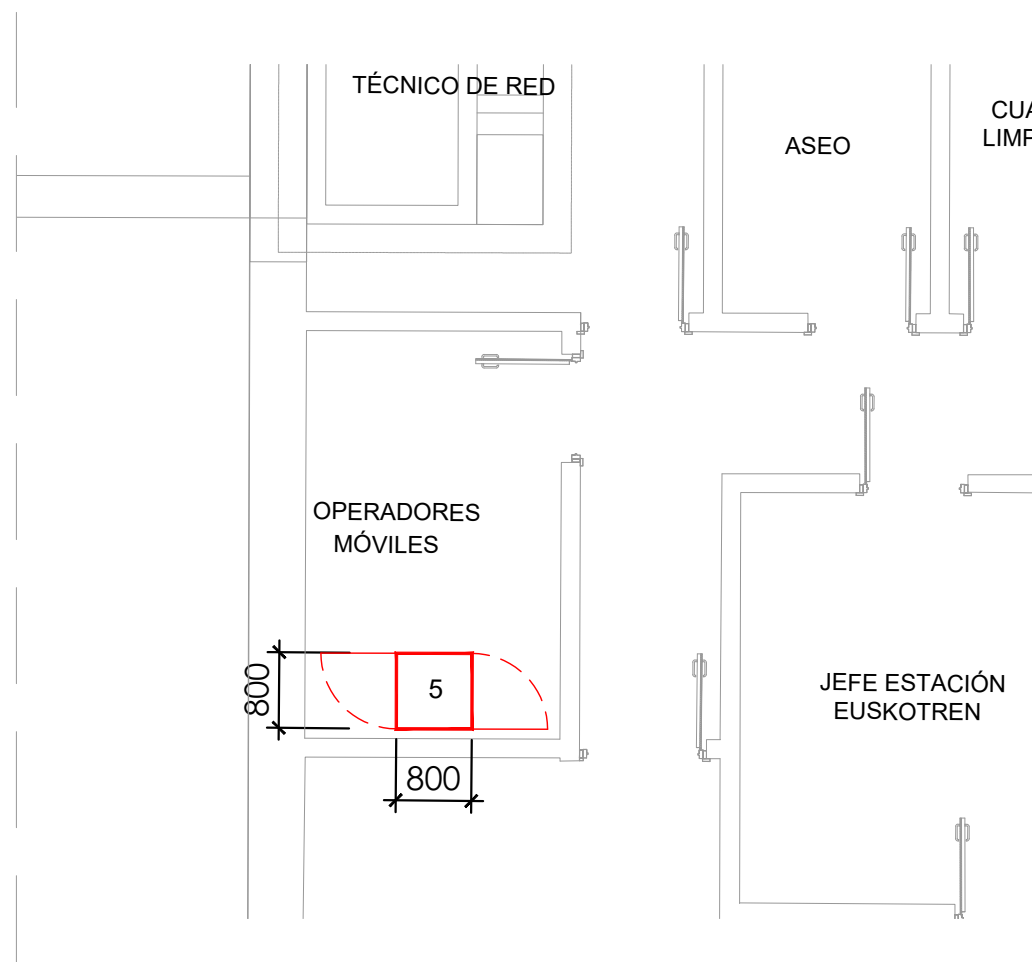
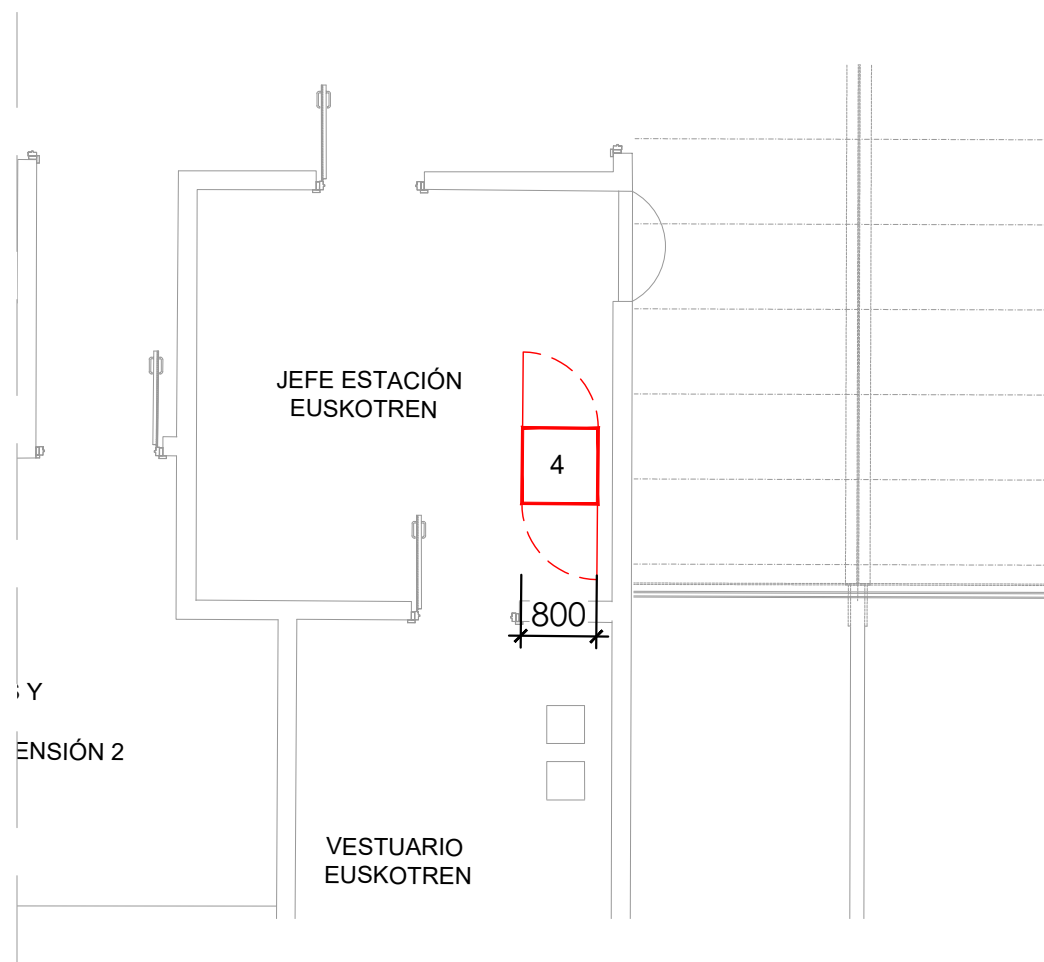

A	PRIMERA EMISION	OCT. 23	A.B.V.	J.I.A.
REV.	CLASE DE MODIFICACION	FECHA	NOMBRE	COMP. OBRA

BERRIKUSPENAK / REVISIONES

AHOLKULARIA / CONSULTOR	INGENIARI EGILEA / INGENIERO AUTOR
SYSTRA	JUAN IRIZAR APARICIO Ingeniero Industrial

AHOLKULARIAREN ERREFERENTZIA / REFERENCIA CONSULTOR	ERREFERENTZIA / REFERENCIA
-----------------------------------------------------	----------------------------

MD-C-23-202-A

REF: MD-C-23-202-A.dwg

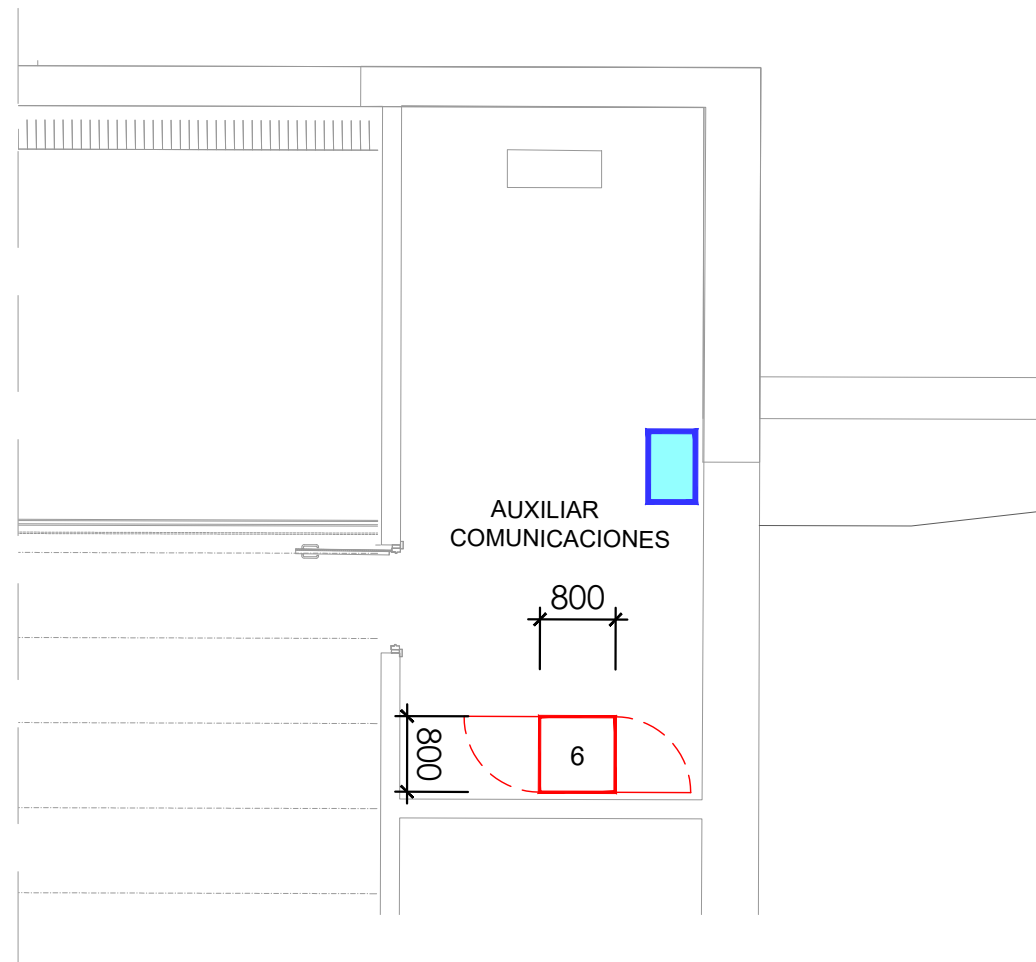
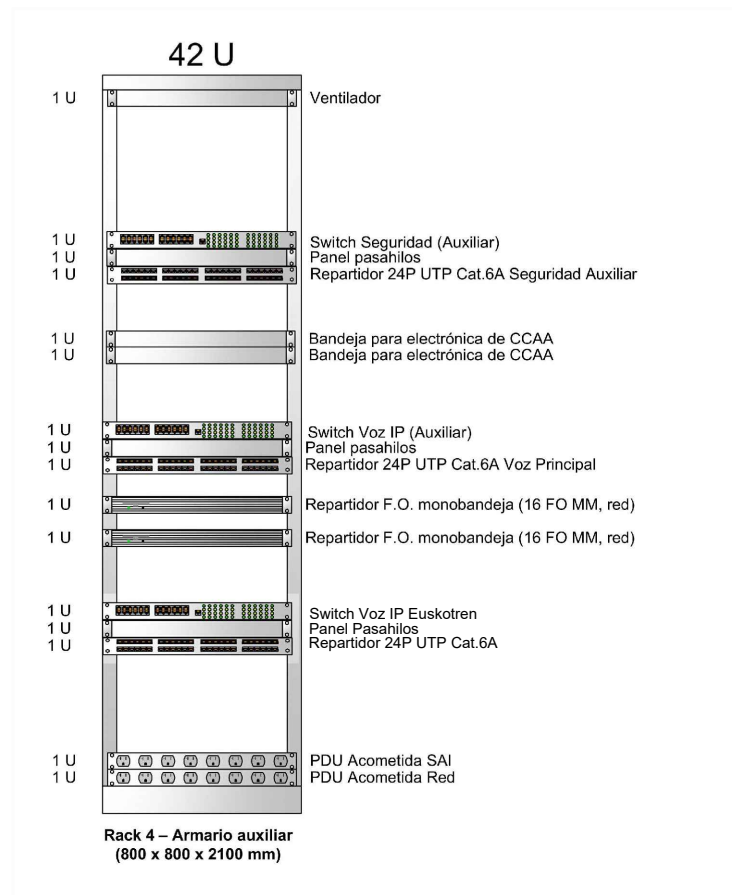

OHARRAK:
NOTAS:

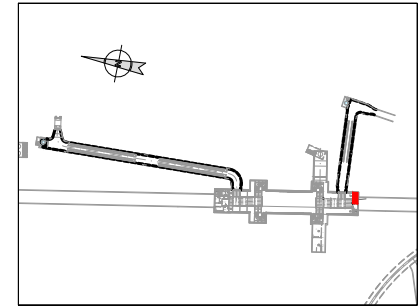

LEYENDA

- 6 RACK ARMARIO AUXILIAR 42U
- ARMARIO MURAL DISTRIBUCIÓN TETRA

A	PRIMERA EMISION	OCT. 23	A.B.V.	J.I.A.
REV.	CLASE DE MODIFICACION	FECHA	NOMBRE	COMP. OBRA
BERRIKUSPENAK / REVISIONES				
AHOLKULARIA / CONSULTOR				
AHOLKULARIAREN ERREFERENTZIA REFERENCIA CONSULTOR	 JUAN IRIZAR APARICIO <small>Ingeniero Industrial</small>			
ERREFERENTZIA REFERENCIA	MD-C-23-203-A			

REF: MD-C-23-203-A.dwg

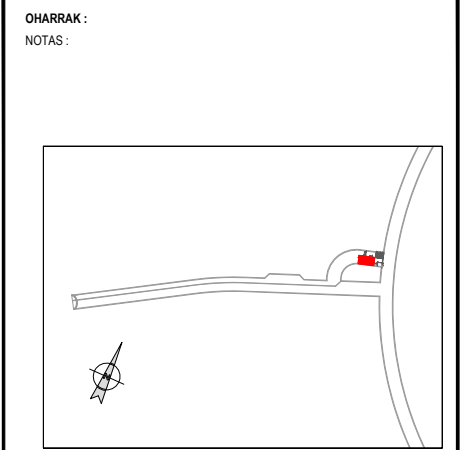
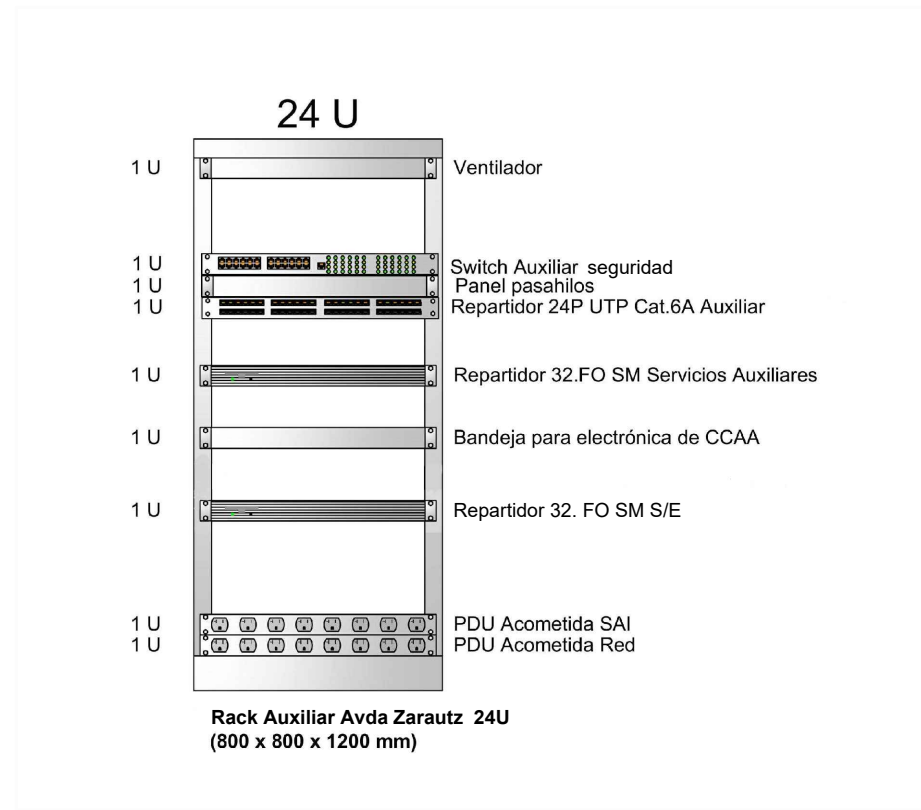

LEYENDA

RACK AUXILIAR AVENIDA ZARAUTZ

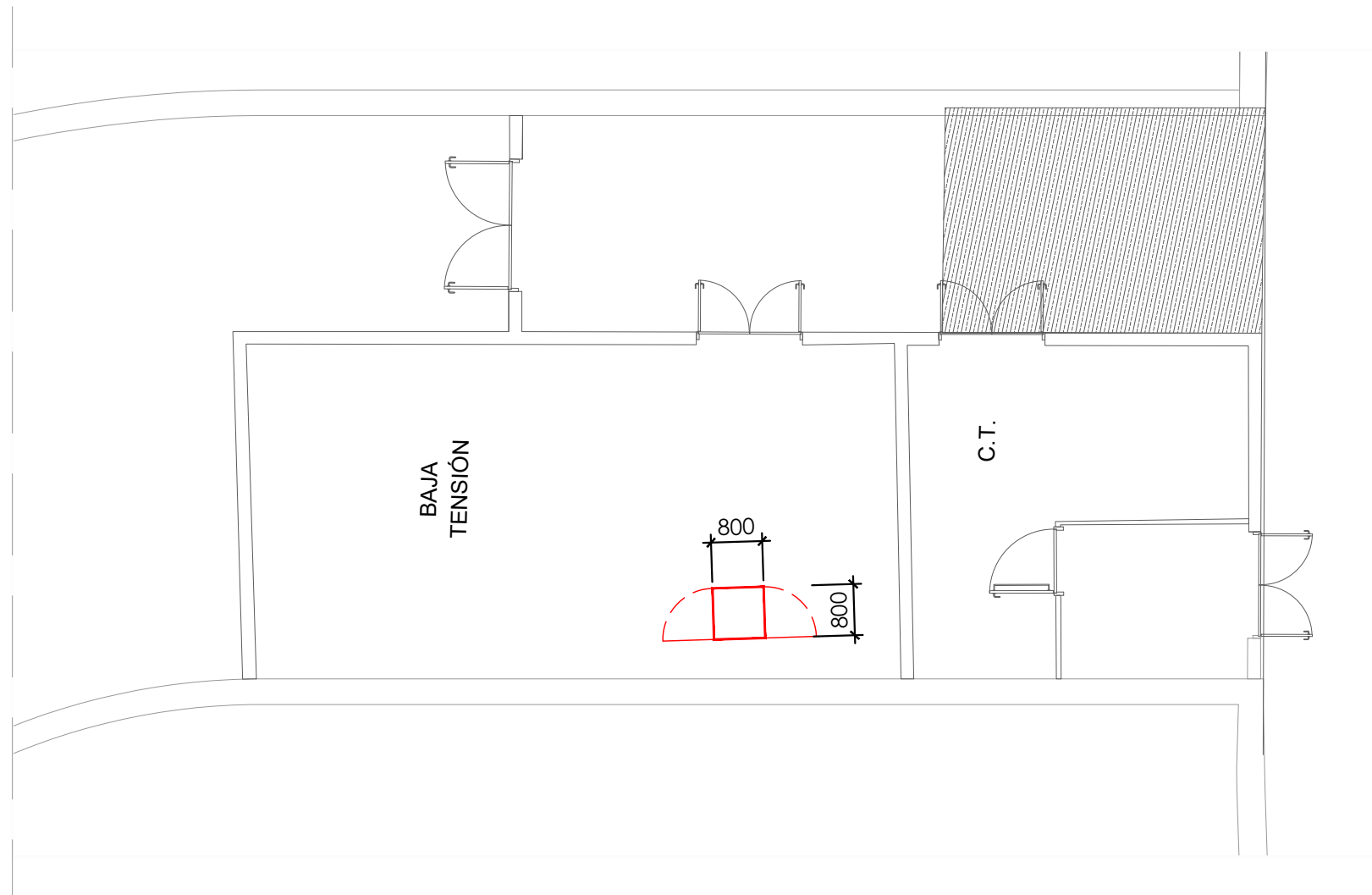

A	PRIMERA EMISION	OCT. 23	A.B.V.	J.I.A.	
REV.	CLASE DE MODIFICACION	FECHA	NOMBRE	COMP.	OBRA
BERRIKUSPENAK / REVISIONES					
AHOLKULARIA / CONSULTOR 			INGENIARI EGILEA / INGENIERO AUTOR JUAN IRIZAR APARTICIO <small>Ingeniero Industrial</small>		
AHOLKULARIAREN ERREFERENTZIA / REFERENCIA CONSULTOR			ERREFERENTZIA / REFERENCIA		
MD-C-23-204-A					

REF: MD-C-23-204-A.dwg

OHARRAK:
NOTAS:

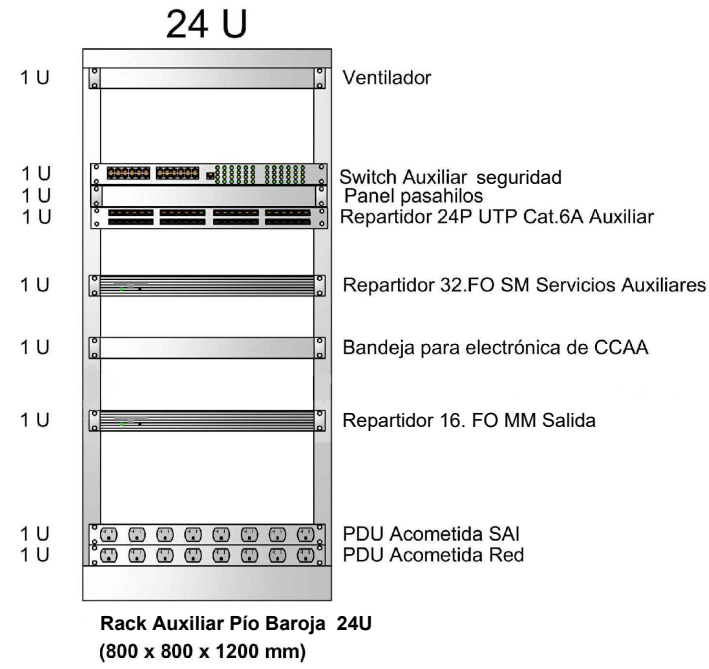
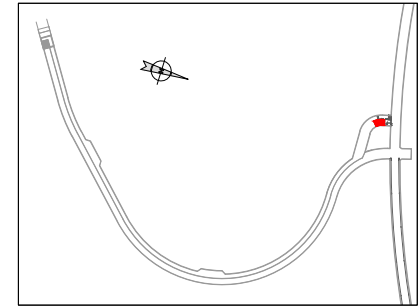

LEYENDA

RACK AUXILIAR PIO BAROJA

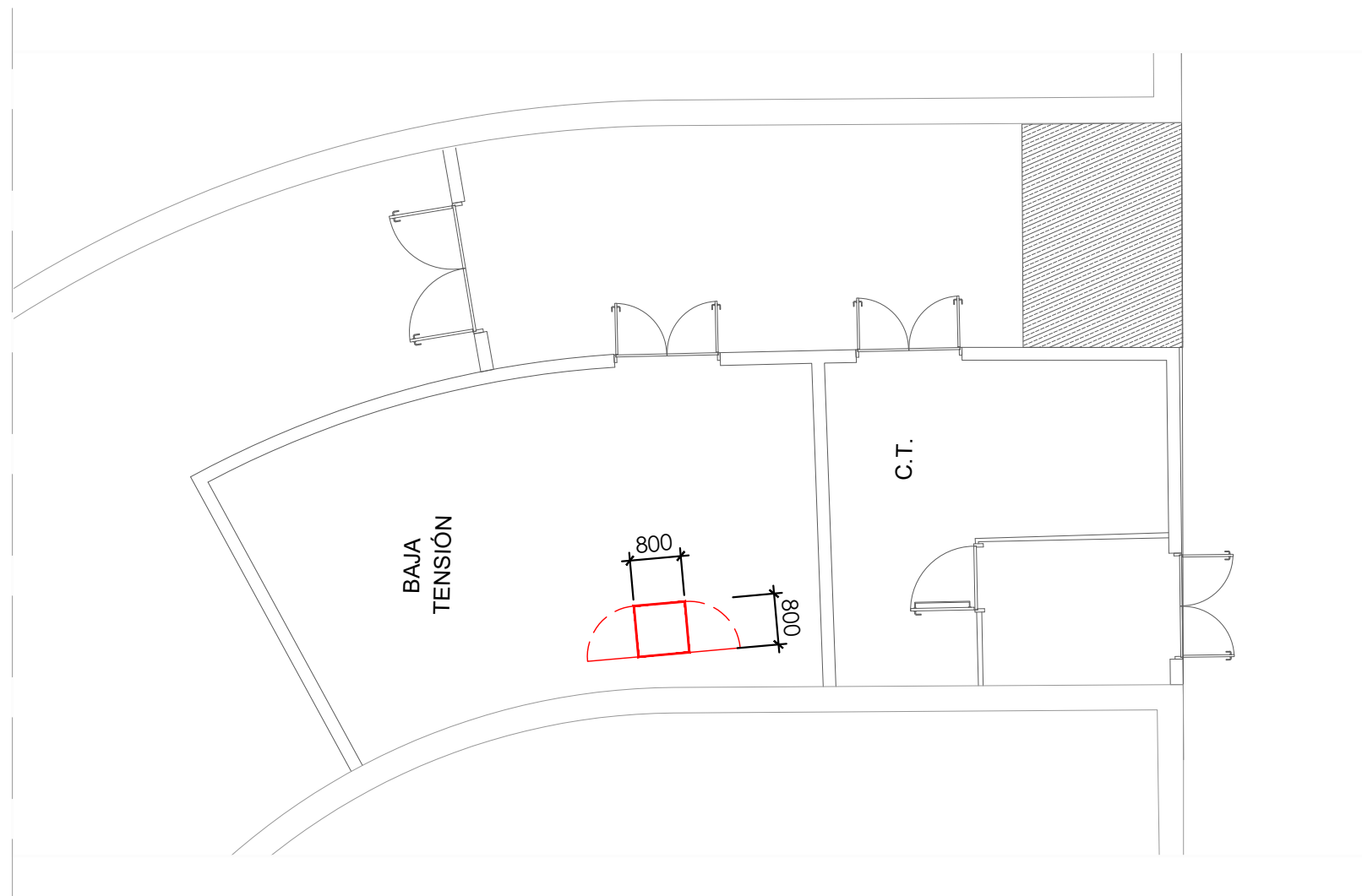

REV.	CLASE DE MODIFICACION	FECHA	NOMBRE	COMP.	OBRA
A	PRIMERA EMISION	OCT. 23	A.B.V.	J.I.A.	

BERRIKUSPENAK / REVISIONES

AHOLKULARIA / CONSULTOR	INGENIARI EGILEA INGENIERO AUTOR
AHOLKULARIAREN ERREFERENTZIA REFERENCIA CONSULTOR	ERREFERENTZIA REFERENCIA
	MD-C-23-205-A

REF: MD-C-23-205-A.dwg